



RPI Is Your Best Source For PM Kits to fit Oil-Less & Lubricated Dental Compressors!

DENTAL COMPRESSORS – Air Techniques, Apollo/Midmark®, DentalEZ®, Custom Air/Jun-Air/RamVac, MatrX/Midmark®, Midmark®, & Tech West

OIL-LESS COMPRESSOR PM KITS *(continued on page 2)*

OEM Models	RPI Part #	OEM Part #	Parts Included In Compressor PM Kit
AIR TECHNIQUES			
AirStar 1 AirStar 10	CMK141	87351	Air Filter Element Kit (RPI Part #CMK065), Filter Element (RPI Part #CME102) and Filter Element (RPI Part #CME103)
AirStar 2-1 AirStar 2-2 AirStar 3 AirStar 21 AirStar 22 AirStar 30	CMK142	87352	(2) Air Filter Element Kit (RPI Part #CMK065), Filter Element (RPI Part #CME102) and Filter Element (RPI Part #CME103)
AirStar 40 AirStar 40 NEO	CMK199	87355	(3) Air Filter Element Kit (RPI Part #CMK065), Filter Element (RPI Part #CME102) and Filter Element (RPI Part #CME103)
AirStar 5 AirStar 50	CMK143	87353	(4) Air Filter Element Kit (RPI Part #CMK065), Filter Element (RPI Part #CME102) and Filter Element (RPI Part #CME103)
AirStar 7 AirStar 70	CMK144	87354	(6) Air Filter Element Kit (RPI Part #CMK065), (2) Filter Element (RPI Part #CME102) and (2) Filter Element (RPI Part #CME103)
AirStar 100M	CMK278	87356	(8) Air Filter Element Kit (RPI Part #CMK065), (2) Filter Element (RPI Part #CME102) and (2) Filter Element (RPI Part #CME103)

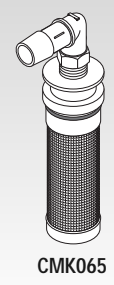
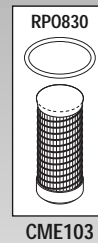
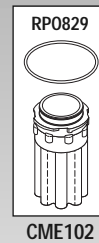

replacement parts industries, inc.

CALL (800) 221-9723 • FAX (818) 882-7028 • EMAIL order@ripiparts.com • WEBSITE www.ripiparts.com

The above parts are manufactured by Replacement Parts Industries, Inc. to fit the equipment noted. All product names used in this document are trademarks or registered trademarks of their respective holders. Show 10/19

OIL-LESS COMPRESSOR PM KITS (continued from page 1)

OEM Models	RPI Part #	OEM Part #	Parts Included In Compressor PM Kit
APOLLO/MIDMARK®			
AOCOS11/D/DQ/Q AOCOS12/D/DQ/Q AOCOS21/D/DQ/Q AOCOS22/D/DQ/Q AOCRT21DQ/Q AOCRT22DQ/Q R22 (with 10 gal tank)	CMK170	ACA85403 & ACA85417	(2) Replacement Filter Element (RPI Part #CME004) and Coalescing Filter Element (RPI Part #CMK024)
AOCOS31/D/DQ/Q AOCOS32/D/DQ/Q AOCOS42/D/DQ/Q AOCOT32/D/DQ/Q AOCOT42/D/DQ/Q	CMK171	ACA85404	(4) Replacement Filter Element (RPI Part #CME004) and Coalescing Filter Element (RPI Part #CMK025)
AOCOT62/D/DQ/Q AOCOT82/D/DQ/Q	CMK172	ACA85406	(8) Replacement Filter Element (RPI Part #CME004) and Coalescing Filter Element (RPI Part #CMK025)
AOCRS11 (Manufactured before Apollo was acquired by Midmark) AOCRS12 (Manufactured before Apollo was acquired by Midmark)	CMK270	No OEM Part # Available	Air Filter Element (RPI Part #CME288) and Particle Filter Element (RPI Part #CME085)
AOCRS11 (Manufactured after Apollo was acquired by Midmark) AOCRS12 (Manufactured after Apollo was acquired by Midmark)	CMK271	No OEM Part # Available	Replacement Filter Element (RPI Part #CME004) and Particle Filter Element (RPI Part #CME085)
AOCRR42DQ R22 (with 20, 30, or 40 gal tank) R42	CMK273	ACA85418	(3) Replacement Filter Element (RPI Part #CME004) and Coalescing Filter Element (RPI Part #CMK025)
AOCOS52 AOCOS52D	CMK274 ¹	ACA85415	Air Intake Filter Element (RPI Part #CME281) and Coalescing Filter Element (RPI Part #CMK025)
AOCOS52 AOCOS52D	CMK286 ¹	ACA85416	Air Intake Filter Element (RPI Part #CME281), Coalescing Filter Element (RPI Part #CMK025) and Compressor Tip Seal Kit (RPI Part #CMK287)
DENTALEZ®/CUSTOM AIR/JUN-AIR/RAMVAC			
1013D 1023D 1025D 1027D	CMK076 ²	004016	(2) Air Filter Element (RPI Part #CME067), Coalescing Filter Element (RPI Part #CME043) and Coalescing Filter Element (RPI Part #CME044)
1022	CMK092 ²	004015	Air Filter Element (RPI Part #CME067), (Coalescing Filter Element (RPI Part #CME043) and Coalescing Filter Element (RPI Part #CME044)
1029T	CMK101 ²	004017	(3) Air Filter Element (RPI Part #CME067), Coalescing Filter Element (RPI Part #CME043) and Coalescing Filter Element (RPI Part #CME044)
CA-812 CA-822 CA-912 CA-922	CMK145	65468179	Intake Filter Element (RPI Part #CME074) and (2) Coalescing Filter Element (RPI Part #CME105)
CA-813-D (SN 440537 and below) CA-823-D (SN 440537 and below)	CMK146	65468180	(2) Air Intake Filter (RPI Part #CMF073) and (2) Coalescing Filter Element (RPI Part #CME105)
CA-813/D (SN 440538 - 631602) CA-823/D (SN 440538 - 631602) CA-913 (SN 440538 - 631602) CA-923 (SN 440538 - 631602)	CMK147	65468186	(4) Intake Filter (RPI Part #CMF075) and (2) Coalescing Filter Element (RPI Part #CME105)
CA-813/D (SN 631603 and above) CA-823/D (SN 631603 and above) CA-913 (SN 631603 and above) CA-923 (SN 631603 and above)	CMK191	004444	(4) Intake Filter (RPI Part #CMF075) and (2) Filter Element (RPI Part #CME107)
CA-825/D/Q (SN 631602 and below) CA-925/D (SN 631602 and below)	CMK148	65468181	(2) Intake Filter Element (RPI Part #CME074) and (2) Coalescing Filter Element (RPI Part #CME105)
CA-825/D/Q (SN 631603 and above) CA-925/D (SN 631603 and above)	CMK192	004445	(2) Intake Filter Element (RPI Part #CME074) and (2) Filter Element (RPI Part #CME107)
CA-827-D (SN 631602 and below) CA-927-D (SN 631602 and below)	CMK149	65468182	(3) Intake Filter Element (RPI Part #CME074) and (2) Coalescing Filter Element (RPI Part #CME105)
CA-827-D (SN 631603 and above) CA-927-D (SN 631603 and above)	CMK193	004446	(3) Intake Filter Element (RPI Part #CME074) and (2) Filter Element (RPI Part #CME107)
CA-829-D (SN 631602 and below) CA-929-D (SN 631602 and below)	CMK150	65468183	(4) Intake Filter Element (RPI Part #CME074) and (2) Coalescing Filter Element (RPI Part #CME105)

(continued on page 3)

Footnotes: ¹ This Kit only fits Compressors that have been upgraded with the RPI Air Intake Upgrade Kit (Round Style Housing) (RPI Part #CMK280)
² Fits only Dentalez/Custom Air/RamVac Compressors

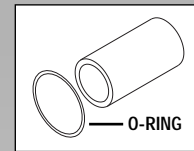

O-RING
CME004

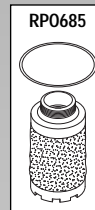

RPO685
CME043



RPO685
CME044

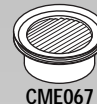

CME067

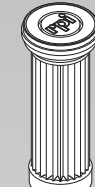

CME074

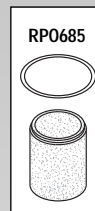

RPO685
CME085

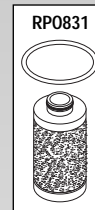

RPO831
CME105

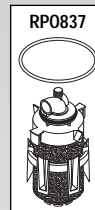

RPO837
CME107



CME281

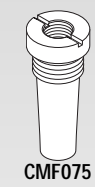

CMF075



CME288

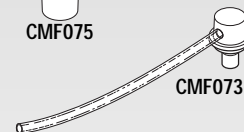

CMF073

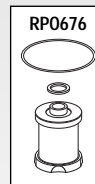

RPO676
CMK024

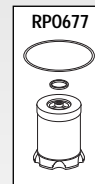

RPO677
CMK025

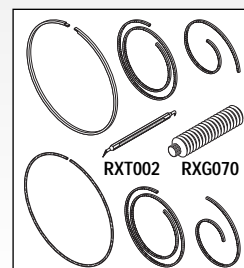

RXT002 RXG070
CMK287

OIL-LESS COMPRESSOR PM KITS (continued from page 2)

OEM Models	RPI Part #	OEM Part #	Parts Included In Compressor PM Kit
DENTALEZ®/CUSTOM AIR/JUN-AIR/RAMVAC (continued)			
CA-829-D (SN 631603 and above)	CMK194	004449	(4) Intake Filter Element (RPI Part #CME074) and (2) Filter Element (RPI Part #CME107)
CA-929-D (SN 631603 and above)			
CA-8212-T (SN 631602 and below)	CMK151	65468184	(6) Intake Filter Element (RPI Part #CME074) and (2) Coalescing Filter Element (RPI Part #CME105)
CA-8212-T (SN 631603 and above)	CMK195	004447	(6) Intake Filter Element (RPI Part #CME074) and (2) Filter Element (RPI Part #CME107)
Osprey 13 Osprey 22 Osprey 23	CMK223	005147SP	(2) Air Filter Element (RPI Part #CME067), Coalescing Filter Element (RPI Part #CME227) and Particulate Filter Element (RPI Part #CME228)
Osprey 24	CMK226	005350SP	(3) Air Filter Element (RPI Part #CME067), Coalescing Filter Element RPI Part #CME227) and Particulate Filter Element (RPI Part #CME228)
Osprey 25	CMK224	005148SP	(4) Air Filter Element (RPI Part #CME067), Coalescing Filter Element (RPI Part #CME227) and Particulate Filter Element (RPI Part #CME228)
Osprey 28	CMK225	005149SP	(6) Air Filter Element (RPI Part #CME067), Coalescing Filter Element (RPI Part #CME227) and Particulate Filter Element (RPI Part #CME228)
MATRIX/MIDMARK®			
OL-100 OL-101	CMK161	No OEM Part # Available	(3) Foam Element (RPI Part #CMF013) and Coalescing Filter Element (RPI Part #CMK024)
OL-100-2	CMK162	No OEM Part # Available	(5) Foam Element (RPI Part #CMF013) and Coalescing Filter Element (RPI Part #CMK024)
OL-100-3	CMK163	No OEM Part # Available	(6) Foam Element (RPI Part #CMF013) and Coalescing Filter Element (RPI Part #CMK024)
OL-3 OL-2000 OL-2001	CMK164	No OEM Part # Available	(2) Air Filter Element (RPI Part #CME071) and Coalescing Filter Element (RPI Part #CMK024)
OL-7 OL-4000	CMK165	No OEM Part # Available	(4) Air Filter Element (RPI Part #CME071) and Coalescing Filter Element (RPI Part #CMK024)
OL-10 OL-6000	CMK166	No OEM Part # Available	(6) Air Filter Element (RPI Part #CME071) and Coalescing Filter Element (RPI Part #CMK024)
MIDMARK®			
P21	CMK155	77001636	(2) Replacement Filter Element (RPI Part #CME004) and Coalescing Filter Element (RPI Part #CMK025)
P22			
P32	CMK198	77001636	(3) Replacement Filter Element (RPI Part #CME004) and Coalescing Filter Element (RPI Part #CMK025)
P52	CMK156	77001610	(4) Air Filter Element (RPI Part #CME071) and Coalescing Filter Element (RPI Part #CMK025)
P72	CMK157	77001611	(6) Air Filter Element (RPI Part #CME071) and Coalescing Filter Element (RPI Part #CMK025)
S52	CMK274 ¹	ACA85415	Air Intake Filter Element (RPI Part #CME281) and Coalescing Filter Element (RPI Part #CMK025)
S52	CMK286 ¹	ACA85416	Air Intake Filter Element (RPI Part #CME281), Coalescing Filter Element (RPI Part #CMK025) and Compressor Tip Seal Kit (RPI Part #CMK287)
TECH WEST			
ACO2S1/ND (2005 and earlier)	CMK174	CSKO-1	(2) Air Filter Element (RPI Part #CME067) and Coalescing Filter Element (RPI Part #CMK025)
ACO2S2/ND (2005 and earlier)			
ACO2S1/ND (2006 and later)	CMK175	CSKO-1P	(2) Air Filter Element (RPI Part #CME067) and Coalescing Filter Element (RPI Part #CME110)
ACO2S2/ND (2006 and later)			
ACO4S2/ND (2005 and earlier)	CMK176	CSKO-2	(4) Air Filter Element (RPI Part #CME067) and Coalescing Filter Element (RPI Part #CMK025)
ACO4D2/ND (2005 and earlier)			
ACO4D2/ND (2006 and later)	CMK177	CSKO-2P	(4) Air Filter Element (RPI Part #CME067) and Coalescing Filter Element (RPI Part #CME110)
ACO6T2/ND (2005 and earlier)	CMK178	CSKO-3	(6) Air Filter Element (RPI Part #CME067) and Coalescing Filter Element (RPI Part #CMK025)
ACO6T2/ND (2006 and later)	CMK179	CSKO-3P	(6) Air Filter Element (RPI Part #CME067) and Coalescing Filter Element (RPI Part #CME110)
ACOR2D1 ACOR2D1Q ACOR2D2 ACOR2D2Q ACOR3T2 ACOR3T2Q	CMK275	No OEM Part # Available	Air Filter Element (RPI Part #CME067) and Coalescing Filter Element (RPI Part #CME110)
ACOR4Q2	CMK277	No OEM Part # Available	Air Filter Element (RPI Part #CME069) and Coalescing Filter Element (RPI Part #CME110)

Footnotes: ¹ This Kit only fits Compressors that have been upgraded with the RPI Air Intake Upgrade Kit (Round Style Housing) (RPI Part #CMK280)

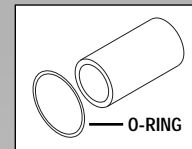

O-RING

CME004



CME067



CME069

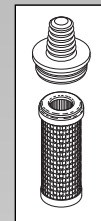

CME071

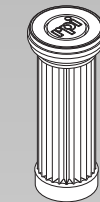

CME074

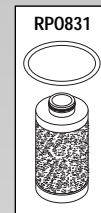

RP0831

CME105

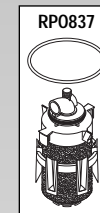

RP0837

CME107

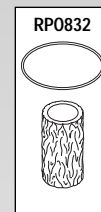

RP0832

CME110



CMG254

CME227

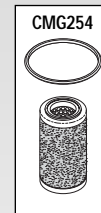

CMG254

CME228



CME281

CMF013

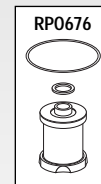

RP0676

CMK024

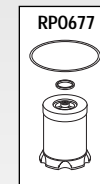

RP0677

CMK025

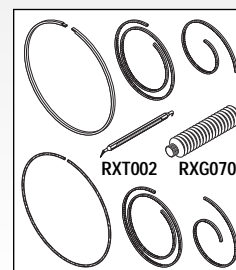

RXT002 RYG070

CMK287



LUBRICATED COMPRESSOR PM KITS

OEM Models	RPI Part #	OEM Part #	Parts Included In Compressor PM Kit
APOLLO/MIDMARK®			
ALCQL82/D	CMK173	ACA85407	(4) Replacement Filter Element (RPI Part #CME004), Coalescing Filter Element (RPI Part #CMK025), (4) Compressor Oil (RPI Part #CML001) and (1 pc) Disposal Bag (RPI Part #RPB838)
ALCRL62/D	CMK160	ACA85402	(3) Replacement Filter Element (RPI Part #CME004), Coalescing Filter Element (RPI Part #CMK025), (3) Compressor Oil (RPI Part #CML001) and (1 pc) Disposal Bag (RPI Part #RPB838)
ALCSL11/D ALCSL12/D ALCSL21/D ALCSL22/D	CMK167	ACA85400	Replacement Filter Element (RPI Part #CME004), Coalescing Filter Element (RPI Part #CMK024), Compressor Oil (RPI Part #CML001) and (1 pc) Disposal Bag (RPI Part #RPB838)
ALCTL31/D ALCTL32/D ALCTL41/D ALCTL42/D	CMK159	ACA85401	(2) Replacement Filter Element (RPI Part #CME004), Coalescing Filter Element (RPI Part #CMK025), (2) Compressor Oil (RPI Part #CML001) and (1 pc) Disposal Bag (RPI Part #RPB838)
DENTALEZ®/CUSTOM AIR/JUN-AIR/RAMVAC			
CA-711 CA-721	CMK152	65468176	Air Intake Filter (RPI Part #CMF073), Carbon Filter Element (RPI Part #CME104), Coalescing Filter Element (RPI Part #CME105), (2) Synthetic Compressor Oil (RPI Part #CML119), (1 pc) Disposal Bag (RPI Part #RPB838), O-Ring (Rib Cover Gasket) (RPI Part #RP0848) and (1 pc) Drain Plug Gasket (RPI Part #CMG197)
CA-713 CA-723	CMK153	65468177	(2) Air Intake Filter (RPI Part #CMF073), Carbon Filter Element (RPI Part #CME104), Coalescing Filter Element (RPI Part #CME105), (4) Synthetic Compressor Oil (RPI Part #CML119), (1 pc) Disposal Bag (RPI Part #RPB838), (2) O-Ring (Rib Cover Gasket) (RPI Part #RP0848) and (2 pcs) Drain Plug Gasket (RPI Part #CMG197)
CA-725	CMK154	65468178	(4) Air Intake Filter (RPI Part #CMF073), Carbon Filter Element (RPI Part #CME104), Coalescing Filter Element (RPI Part #CME105), (6) Synthetic Compressor Oil (RPI Part #CML119), (1 pc) Disposal Bag (RPI Part #RPB838), (4) O-Ring (Rib Cover Gasket) (RPI Part #RP0848) and (4 pcs) Drain Plug Gasket (RPI Part #CMG197)
MATRIX/MIDMARK®			
AMD-2 AMD-2-115	CMK185	No OEM Part # Available	(3) Foam Element (RPI Part #CMF013), Coalescing Filter Element (RPI Part #CMK024), Compressor Oil (RPI Part #CML001) and (1 pc) Disposal Bag (RPI Part #RPB838)
AMD-4	CMK186	No OEM Part # Available	(3) Foam Element (RPI Part #CMF013), Coalescing Filter Element (RPI Part #CMK024), (2) Compressor Oil (RPI Part #CML001) and (1 pc) Disposal Bag (RPI Part #RPB838)
AMD-6	CMK187	No OEM Part # Available	(4) Foam Element (RPI Part #CMF013), Coalescing Filter Element (RPI Part #CMK024), (3) Compressor Oil (RPI Part #CML001) and (1 pc) Disposal Bag (RPI Part #RPB838)
AMD-100 AMD-101	CMK167	77000958	Replacement Filter Element (RPI Part #CME004), Coalescing Filter Element (RPI Part #CMK024), Compressor Oil (RPI Part #CML001) and (1 pc) Disposal Bag (RPI Part #RPB838)
AMD-100-2	CMK168	77000959	(2) Replacement Filter Element (RPI Part #CME004), Coalescing Filter Element (RPI Part #CMK024), (2) Compressor Oil (RPI Part #CML001) and (1 pc) Disposal Bag (RPI Part #RPB838)
AMD-100-3	CMK169	77000960	(3) Replacement Filter Element (RPI Part #CME004), Coalescing Filter Element (RPI Part #CMK024), (3) Compressor Oil (RPI Part #CML001) and (1 pc) Disposal Bag (RPI Part #RPB838)
AMD-100 (Manufactured before Midmark acquired Matrix) AMD-102 (Manufactured before Midmark acquired Matrix)	CMK263	No OEM Part # Available	(3) Foam Element (RPI Part #CMF013), Coalescing Filter Element (RPI Part #CMK024), Compressor Oil (RPI Part #CML001) and (1 pc) Disposal Bag (RPI Part #RPB838)

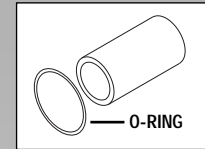

CME004

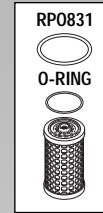

CME104

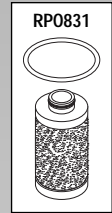

CME105

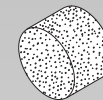

CMF013

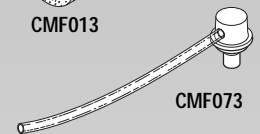

CMF073



CMG197

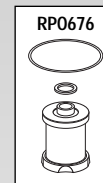

CMK024

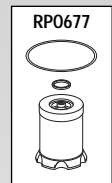

CMK025



CML001



CML119

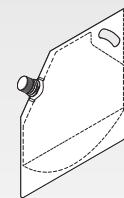

RPB838

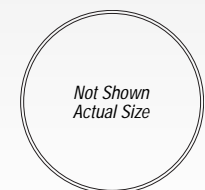

RP0848

(continued on page 5)



LUBRICATED COMPRESSOR PM KITS (continued from page 4)

OEM Models	RPI Part #	OEM Part #	Parts Included In Compressor PM Kit
MATRIX/MIDMARK® (continued)			
AMD-100-2 (Manufactured before Midmark acquired Matrix)	CMK264	No OEM Part # Available	(5) Foam Element (RPI Part #CMF013), Coalescing Filter Element (RPI Part #CMK024), (2) Compressor Oil (RPI Part #CML001) and (1 pc) Disposal Bag (RPI Part #RPB838)
AMD-100-3 (Manufactured before Midmark acquired Matrix)	CMK265	No OEM Part # Available	(6) Foam Element (RPI Part #CMF013), Coalescing Filter Element (RPI Part #CMK024), (3) Compressor Oil (RPI Part #CML001) and (1 pc) Disposal Bag (RPI Part #RPB838)
AC-075 AC-100 AC-101	CMK266	No OEM Part # Available	(3) Foam Element (RPI Part #CMF013), Compressor Oil (RPI Part #CML001) and (1 pc) Disposal Bag (RPI Part #RPB838)
AC-100-2	CMK267	No OEM Part # Available	(5) Foam Element (RPI Part #CMF013), (2) Compressor Oil (RPI Part #CML001) and (1 pc) Disposal Bag (RPI Part #RPB838)
ACD-075 ACD-100 ACD-101	CMK268	No OEM Part # Available	(2) Foam Element (RPI Part #CMF014), Coalescing Filter Element (RPI Part #CMK024), Compressor Oil (RPI Part #CML001) and (1 pc) Disposal Bag (RPI Part #RPB838)
ACD-100-2	CMK269	No OEM Part # Available	(4) Foam Element (RPI Part #CMF014), Coalescing Filter Element (RPI Part #CMK024), (2) Compressor Oil (RPI Part #CML001) and (1 pc) Disposal Bag (RPI Part #RPB838)
MIDMARK®			
CL21 CL22	CMK158	77001633	Replacement Filter Element (RPI Part #CME004), Coalescing Filter Element (RPI Part #CMK025), Compressor Oil (RPI Part #CML001) and (1 pc) Disposal Bag (RPI Part #RPB838)
CL32	CMK159	77001634	(2) Replacement Filter Element (RPI Part #CME004), Coalescing Filter Element (RPI Part #CMK025), (2) Compressor Oil (RPI Part #CML001) and (1 pc) Disposal Bag (RPI Part #RPB838)
CL52	CMK160	77001635	(3) Replacement Filter Element (RPI Part #CME004), Coalescing Filter Element (RPI Part #CMK025), (3) Compressor Oil (RPI Part #CML001) and (1 pc) Disposal Bag (RPI Part #RPB838)
TECH WEST			
ACL2S1/ND (2005 and earlier) ACL2S2/ND (2005 and earlier)	CMK188	CSKL-1	Air Filter Element (RPI Part #CME067), Coalescing Filter Element (RPI Part #CMK025), Compressor Oil (RPI Part #CML001) and (1 pc) Disposal Bag (RPI Part #RPB838)
ACL2S1 (2006 and later) ACL2S2 (2006 and later)	CMK182	CSKL-1P	Air Filter Element (RPI Part #CME067), Coalescing Filter Element (RPI Part #CME110), Compressor Oil (RPI Part #CML001) and (1 pc) Disposal Bag (RPI Part #RPB838)
ACL4D2/ND (2005 and earlier)	CMK189	CSKL-2	Air Filter Element (RPI Part #CME067), Coalescing Filter Element (RPI Part #CMK025), (2) Compressor Oil (RPI Part #CML001) and (1 pc) Disposal Bag (RPI Part #RPB838)
ACL4D2 (2006 and later)	CMK183	CSKL-2P	Air Filter Element (RPI Part #CME067), Coalescing Filter Element (RPI Part #CME110), (2) Compressor Oil (RPI Part #CML001) and (1 pc) Disposal Bag (RPI Part #RPB838)
ACL6T2/ND (2005 and earlier)	CMK190	CSKL-3	Air Filter Element (RPI Part #CME069), Coalescing Filter Element (RPI Part #CMK025), (3) Compressor Oil (RPI Part #CML001) and (1 pc) Disposal Bag (RPI Part #RPB838)
ACL6T2 (2006 and later)	CMK184	CSKL-3P	Air Filter Element (RPI Part #CME069), Coalescing Filter Element (RPI Part #CME110), (3) Compressor Oil (RPI Part #CML001) and (1 pc) Disposal Bag (RPI Part #RPB838)

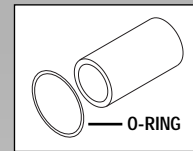

O-RING
CME004

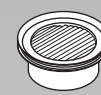

CME067



CME069

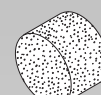

CMF013

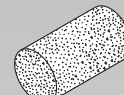

CMF014

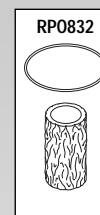

RPO832
CME110

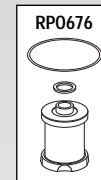

RPO676
CMK024

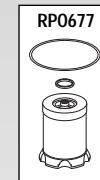

RPO677
CMK025



CML001

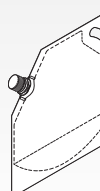

RPB838

Don't Forget RPI's Free Dental Compressor PM Guide!

RPI's easy-to-use Dental Compressor PM Guide walks you through the steps of what to look for and what to replace at monthly and annual intervals. What's more, this PM Guide is easy to personalize with your company's name and phone number which makes a perfect leave behind for your customers as a handy reminder! Download your free copy of RPI's PM Guide from our website, www.rpiparts.com today!

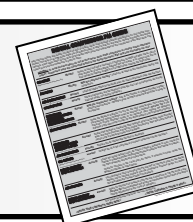

ESSENTIAL PM TOOLS FOR SCROLL STYLE COMPRESSORS!

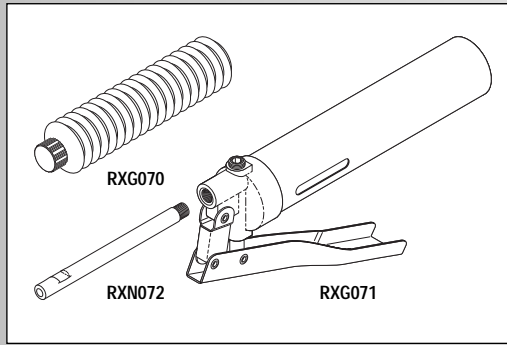

RPI Part #RXK069
OEM Part #HPA30530

GREASE GUN KIT

- OEM recommends regreasing of compressor head and motor bearings every 5,000 hours
- Includes: Grease Gun (RPI Part #RXG071), Grease Gun Nozzle (RPI Part #RXN072), Grease Cartridge (RPI Part #RXG070)
- Used to grease the bearings in the scroll compressor head.

Fits: Scroll Compressor Head

Models: Apollo/Midmark: AOCOS52 & AOCOS52D; Midmark: S52

RPI Part #RXG070
OEM Part #RSS40645
GREASE CARTRIDGE
• 2.8 oz. (80 g) cartridge

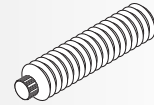

RPI Part #RXG071
OEM Part #HPA30530
GREASE GUN

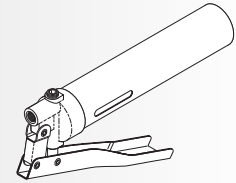

RPI Part #RXN072
OEM Part #HPA30530
GREASE GUN NOZZLE

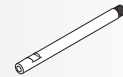

4 ESSENTIAL TOOLS FOR AN EASIER OIL CHANGE!

1 SYRINGE PUMP/EXTRACTOR (RPI Part #RPT842)

This one-of-a-kind tool allows complete removal of oil from a compressor without needing to tilt or disassemble the unit!

2 DRAIN VALVE (RPI Part #RPV841)

Upgrade to RPI's one-of-a-kind Drain Valve which has a special Tee-handle that allows you to easily open and close the valve to control the flow of oil as it is draining into the Disposal Bag!

3 DISPOSAL BAG (RPI Part #RPB838)

The perfect solution for carrying, storing and disposing of used oil. This one gallon bag is constructed of durable clear plastic with an expandable base, a built in handle, and tight sealing cap.

4 COLLECTION CONTAINER KIT (RPI Part #'s CMK180 & CMK181)

These one-of-kind collection bottles can replace the purge drain lines and be directly connected with tubing to the compressor so that the purge waste water and oil can be collected and disposed of properly according to local, state and federal regulations.

- For Pressurized Purge Systems use RPI Part #CMK180
- For Gravity Drain Systems use RPI Part #CMK181

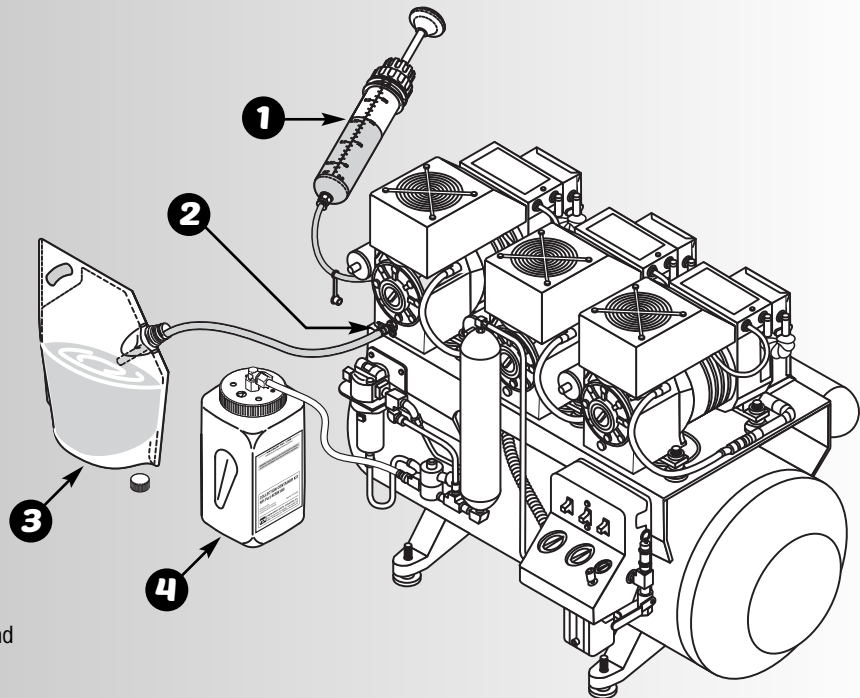

Don't Forget ...

ABSORBENT PAD (RPI Part #RPP958)

This 9-1/4" x 14-1/2" pad is perfect for oil drip collection and spills and is sold in a package of 3!

