

Models: Force 1C, Force 2-2, Force 2-8, Force 4, Force 30, Force 40, Force EZ, Force EZ-C, Force EZ-8, Force EZ-8C, Force FX, Force FX-C, Force FX-8, Force FX-8C & Force Triad

## RPI Offers New Line of Parts to fit Covidien/ValleyLab Electrosurgical Units!

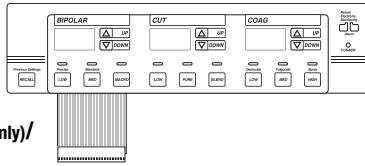

**RPI Part #CVP012**  
**OEM Part #1012634 (Keypad Only)/**  
**223 200 667 (Control Panel Only)**

**KEYPAD (FRONT PANEL)**

- Includes: Front panel keypad and control panel
- Size: 3.34" x 13.44"
- Adhesive backing

**Fits:** Front Panel

**Models:** Force FX & Force FX-C

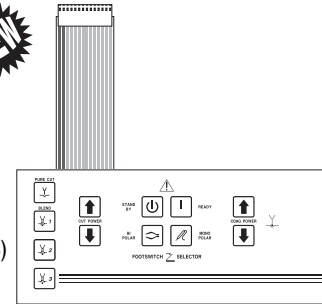

**RPI Part #CVP008**  
**OEM Part #207 500 147**

**KEYPAD (MONOPOLAR)**

- Size: 3.50" x 8.00"
- Material: Anodized aluminum backing panel
- Also available: Adhesive (RTV108) (RPI Part #RPA874)

**Fits:** Front Control Panel

**Models:** Force 2-2

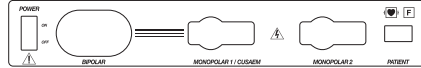

**RPI Part #CVP013**  
**OEM Part #1020029**

**OVERLAY (CONNECTOR PANEL)**

- Size: 2.12" x 13.44"
- Adhesive backing

**Fits:** Front Panel

**Models:** Force FX & Force FX-C

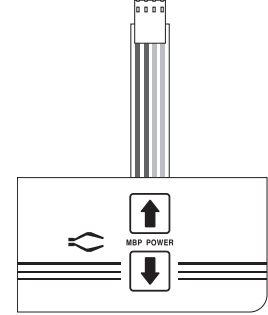

**RPI Part #CVP009**  
**OEM Part #207 500 148**

**KEYPAD (BIPOLAR)**

- Size: 1.75" x 3.25"
- Material: Anodized aluminum backing panel
- Also available: Adhesive (RTV108) (RPI Part #RPA874)

**Fits:** Front Control Panel

**Models:** Force 2-2

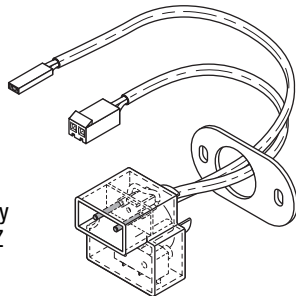

**RPI Part #CVA016**  
**OEM Part #202 701 854**

**RETURN MODULE ASSEMBLY**

- Replacement for the REM® Assembly
- Switch: 0.1A @ 125/250V, 50/60 HZ

**Fits:** Front Panel

**Models:** Force 30, Force 40, Force FX, Force FX-C, Force FX-8 & Force FX-8C

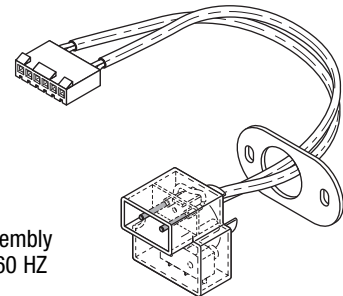

**RPI Part #CVA015**  
**OEM Part # (No OEM Part # Available)**

**RETURN MODULE ASSEMBLY**

- Replacement for the REM® Assembly
- Switch: 0.1A @ 125/250V, 50/60 HZ

**Fits:** Front Panel

**Models:** Force 2-2

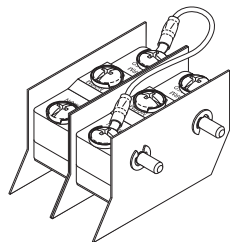

**RPI Part #CVA001**  
**OEM Part # (No OEM Part # Available)**

**FOOTSWITCH ASSEMBLY**

- Monopolar
- 20A @ 125/250VAC

**Fits:** E6008 Monopolar Footswitch

**Models:** Force 1C, Force 2-2, Force 2-8, Force 4, Force 30, Force 40, Force EZ, Force EZ-C, Force EZ-8, Force EZ-8C, Force FX, Force FX-C, Force FX-8, Force FX-8C & Force Triad

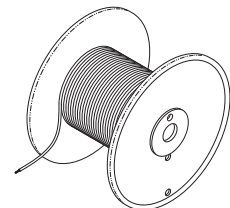

**RPI Part #RPW906**  
**OEM Part # (No OEM Part # Available)**

**HOOK UP WIRE (BLACK)**

- Sold by the foot (reel not included)
- #18 AWG, 16/30 strands, UL 1569
- Insulation: PVC; 221°F (105°C); 300V
- For use with Footswitch Assembly (RPI Part #CVA001)

**Fits:** E6008 Monopolar Footswitch

**Models:** Force 1C, Force 2-2, Force 2-8, Force 4, Force 30, Force 40, Force EZ, Force EZ-C, Force EZ-8, Force EZ-8C, Force FX, Force FX-C, Force FX-8, Force FX-8C & Force Triad



**replacement parts industries, inc.**

CALL (800) 221-9723 • FAX (818) 882-7028 • EMAIL [order@rpiparts.com](mailto:order@rpiparts.com) • WEBSITE [www.rpiparts.com](http://www.rpiparts.com)

The above parts are manufactured by Replacement Parts Industries, Inc. to fit Covidien/ValleyLab equipment. All product names used in this document are trademarks or registered trademarks of their respective holders. Show 01/15

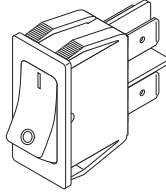

**RPI Part #CVS014**  
**OEM Part #243 025 037**

**POWER SWITCH**

- Rocker Switch (On-Off)
- 16A @ 125/250VAC; DPST
- Black body and rocker
- 1/4" Tabs
- Panel Cutout: .480" x 1.071"

**Fits:** Front Control Panel  
**Models:** Force FX & Force FX-C

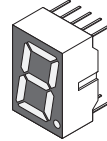

**RPI Part #LMD036**  
**OEM Part #239 750 071**

**NUMERIC DISPLAY LED**

- 3 per package
- 7 Segment display (green)
- Character height: 14.2mm (.56")
- Configuration: 10 Pin DIP

**Fits:** Display Board  
**Models:** Force FX & Force FX-C

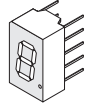

**RPI Part #LMD031**  
**OEM Part #239 750 029**

**NUMERIC DISPLAY LED**

- 3 per package
- 7 Segment display (red)
- Character height: 7.62mm (.30")
- Configuration: 10 Pin DIP

**Fits:** Display Board  
**Models:** Force 2-2

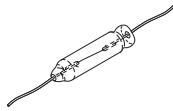

**RPI Part #LMP030**  
**OEM Part #215 200 085**

**LAMP**

- 4 per package
- 12V, .055A, .66W; Axial Lead
- Type: Incandescent
- Can be used in place of radial lead bulb

**Fits:** Display Board  
**Models:** Force FX, Force FX-C & Force 2-2

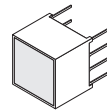

YELLOW/GREEN & RED

**RPI Part #LMD037**  
**OEM Part #239 750 076**

**LED INDICATOR (MULTI)**

- 3 per package
- Bi-color display (yellow/green and red)
- Configuration: 8 Pin DIP

**Fits:** Display Board  
**Models:** Force FX & Force FX-C

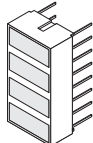

YELLOW

**RPI Part #LMD032**  
**OEM Part #239 750 022**

**LED LIGHT BAR**

- Color: 4 Yellow light emitting sections
- Configuration: 16 Pin DIP

**Fits:** Display Board  
**Models:** Force 2-2

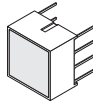

GREEN

**RPI Part #LMD033**  
**OEM Part #239 750 039**

**LED INDICATOR (GREEN)**

- 3 per package
- Configuration: 8 Pin DIP

**Fits:** Display Board  
**Models:** Force 2-2

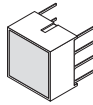

RED

**RPI Part #LMD034**  
**OEM Part #239 750 042**

**LED INDICATOR (RED)**

- 3 per package
- Configuration: 8 Pin DIP

**Fits:** Display Board  
**Models:** Force 2-2

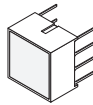

YELLOW

**RPI Part #LMD035**  
**OEM Part #239 750 033**

**LED INDICATOR (YELLOW)**

- 3 per package
- Configuration: 8 Pin DIP

**Fits:** Display Board  
**Models:** Force 2-2

**RPI Part #CVA010**  
**OEM Part #202 701 890**



**LINE FILTER ASSEMBLY**

- 5mm dia. x 20mm lg. fuses not included
- 10A @ 125/250VAC, 50-60 Hz
- Also available: Fuse (8A, 250V) (RPI Part #RPF535) to fit 120VAC Force FX and Force FX-C, and Fuse (4A, 250V) (RPI Part #RPF533) to fit 220VAC Force FX-8 and Force FX-8C

**Fits:** Rear Panel

**Models:** Force FX, Force FX-C, Force FX-8 & Force FX-8C

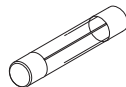
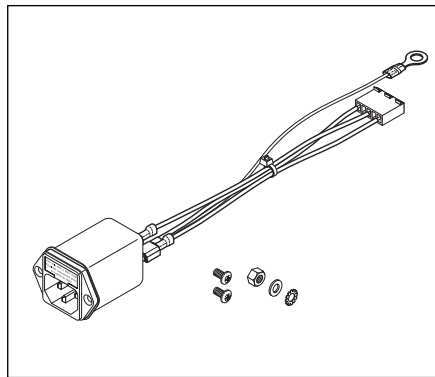

**RPI Part #RPF535**  
**OEM Part #215 100 074**

**FUSE (8A, 250V) - 5mm x 20mm - TIME DELAY**

- 5 per package
- Type: Glass, Time Delay
- Size: 5mm dia. x 20mm lg.
- Included in: Fuse Kit (RPI Part #RPK538)

**Fits:** Line Filter Assembly in 120V Units

**Models:** Force FX and Force FX-C

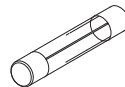

**RPI Part #RPF533**  
**OEM Part #215 100 074**

**FUSE (4A, 250V) - 5mm x 20mm - TIME DELAY**

- 5 per package
- Type: Glass, Time Delay
- Size: 5mm dia. x 20mm lg.
- Included in: Fuse Kit (RPI Part #RPK538)

**Fits:** Line Filter Assembly in 220V Units

**Models:** Force FX-8 and FX-8C



**RPI Part #CVA007**  
**OEM Part #** (No OEM Part # Available)

**VOLUME CONTROL ASSEMBLY**

- 100 Ω Potentiometer
- 19" lg. wires with connector
- Includes all parts as shown

**Fits:** Rear Panel

**Models:** Force 2-2

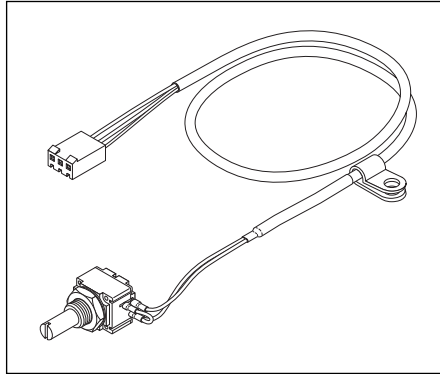

**CVR004**

**CVR003**

X8

**RPI Part #CVA002**  
**OEM Part #** (No OEM Part # Available)

**FOOTSWITCH RECEPTACLE ASSEMBLY**

- 25" lg. shielded cable
- Includes all parts as shown

**Fits:** Rear Panel

**Models:** Force 2-2

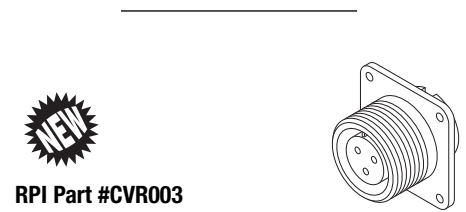

**RPI Part #CVA005**  
**OEM Part #** (No OEM Part # Available)

**POWER HARNESS ASSEMBLY**

- Includes all parts as shown
- Fits:** Rear Panel to Transformer
- Models:** Force 2-2

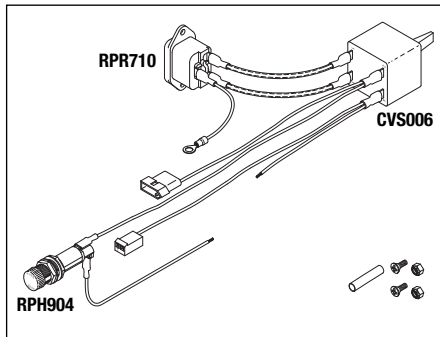

**RPI Part #CVS006**  
**OEM Part #** (No OEM Part # Available)

**POWER SWITCH/CIRCUIT BREAKER**

- Toggle Switch (On-Off); 12.5A circuit breaker
- 12.5A @ 125/250VAC, 50/60 Hz
- 1/4" Tabs
- Mounting hole size: .500" dia.
- Includes: Mounting hardware

**Fits:** Rear Panel

**Models:** Force 2-2

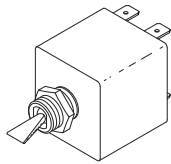

**RPI Part #RPH904**  
**OEM Part #** (No OEM Part # Available)

**FUSE HOLDER**

- Accommodates standard 1/4" x 1-1/4" fuse
- 20A @ 250VAC
- 1/4" Tabs; Black body
- Mounting hole size: .500" dia.; Mounts through front or rear of panel
- Includes: Mounting hardware
- Also available: Fuse (1A, 250V) (RPI Part #RPF045)

**Fits:** Rear Panel  
**Models:** Force 2-2

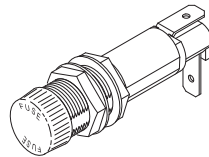

**RPI Part #RPR710**  
**OEM Part #** (No OEM Part # Available)

**AC INLET RECEPTACLE**

- 15A @ 125VAC
- 1/4" Tabs
- Keyed Mating Feature
- Includes: Mounting hardware
- Fits panel cut-out: .787" x 1.083"

**Models:** Force 2-2

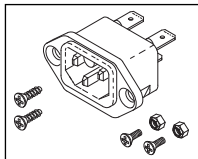

**RPI Part #RPF045**  
**OEM Part #** (No OEM Part # Available)

**FUSE (1A, 250V) - 1/4 x 1-1/4 - FAST ACTING**

- 5 per package
- Type: Glass, AGC Fast Acting
- Size: 1/4" dia. x 1-1/4" lg.

**Fits:** Fuse Holder (RPI Part #RPH904)  
**Models:** Force 2-2

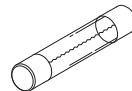

**RPI Part #CVR003**  
**OEM Part #** (No OEM Part # Available)

**BIPOLAR RECEPTACLE**

- 3-Socket receptacle
- Material: Aluminum body, clear finish
- Termination style: Solder
- Included in: Footswitch Receptacle Assembly (RPI Part #CVA002)

**Fits:** Rear Panel

**Models:** Force 1C, Force 2-2, Force 2-8, Force 4, Force 30, Force 40, Force EZ, Force EZ-C, Force EZ-8, Force EZ-8C, Force FX, Force FX-C, Force FX-8, Force FX-8C & Force Triad

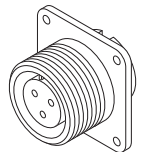

**RPI Part #CVR004**  
**OEM Part #** (No OEM Part # Available)

**MONOPOLAR RECEPTACLE**

- 4-Socket receptacle
- Material: Aluminum body, clear finish
- Termination style: Solder
- Included in: Footswitch Receptacle Assembly (RPI Part #CVA002)

**Fits:** Rear Panel

**Models:** Force 1C, Force 2-2, Force 2-8, Force 4, Force 30, Force 40, Force EZ, Force EZ-C, Force EZ-8, Force EZ-8C, Force FX, Force FX-C, Force FX-8, Force FX-8C & Force Triad

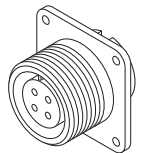



replacement parts industries, inc.

20338 Corisco Street • Chatsworth, California • 91311

PRESORTED STANDARD  
U.S. POSTAGE PAID  
VAN NUYS, CA  
PERMIT NO. 2399

ADDRESS SERVICES REQUESTED

RPI Offers New Line of Parts to fit Covidien/ValleyLab Electrosurgical Units!

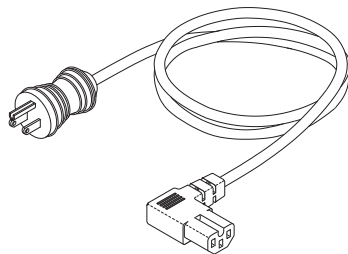

RPI Part #RPC881

OEM Part # (No OEM Part # Available)

HOSPITAL GRADE POWER CORD

- Length: 15 ft.; Color: Gray
- 16/3 SJT, 105°C, 13A @ 125VAC
- Plug Type: NEMA 5-15P; Clear
- Connector Type: EN60320-C15 Right Angle (keyed mating feature)

Fits: Power Entry Module

Models: Force 2-2

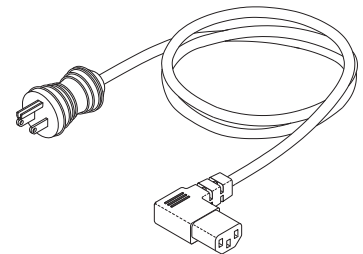

RPI Part #RPC784

OEM Part #207 002 060

HOSPITAL GRADE POWER CORD

- Length: 18 ft.; Color: Gray
- 16/3 SJT, 105°C, 13A @ 125VAC
- Plug Type: NEMA 5-15P
- Connector Type: EN60320-C13R

Models: Force FX and Force FX-C

RPI Part #RPA874

OEM Part # (No OEM Part # Available)

ADHESIVE (RTV108)

- Size: 2.8 fl. oz. tube
- Translucent silicone adhesive/sealant
- Temperature Range: -75°F to +400°F

Models: Force 2-2

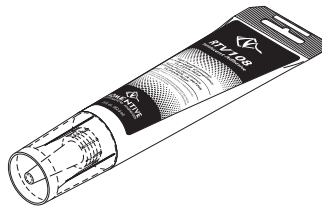

RPI Part #RPF882

OEM Part #215 100 041

FUSE (6.3A, 250V) - 5mm x 20mm - FAST ACTING

- 5 per package
- Type: Glass, AGC Fast Acting
- Size: 5mm dia. x 20mm lg.

Fits: Power Supply/RF Board

Models: Force 2-8, Force 30, Force 40, Force EZ, Force EZ-C, Force EZ-8, Force EZ-8C, Force FX, Force FX-C, Force FX-8 & Force FX-8C

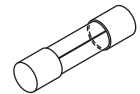

RPI Part #RPF052

OEM Part #215 005 039

FUSE (6A, 250V) - 1/4 x 1-1/4 - FAST ACTING

- 5 per package
- Type: Glass, AGC Fast Acting
- Size: 1/4" dia. x 1-1/4" lg.
- Included in: Fuse Kit (RPI Part #RPK410)

Fits: Power Supply/RF board

Models: Force 2-2 & Force 4

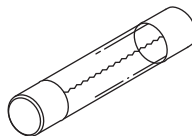

RPI Part #RPF367

OEM Part # (No OEM Part # Available)

FUSE (2A, 250V) - 5mm x 20mm - FAST ACTING

- 5 per package
- Type: Glass, AGC Fast Acting
- Size: 5mm dia. x 20mm lg.
- Included in: Fuse Kit (RPI Part #RPK520)

Fits: Force FX-C with Low Voltage Boards

Models: Force FX-C

