



New and Existing Parts to fit AIR TECHNIQUES DENTAL FILM PROCESSORS

Peri-Pro® & Peri-Pro II®

Now Includes

"L" Transfer Arm Bushings, "U" Transfer Drive Bushings & the Rubber Bumper!

RPI Part #ATK629
OEM Part #90988

TRANSPORT REPAIR KIT

• Kit includes quantities as noted
Fits: Transport Assembly
Models: Peri-Pro & Peri-Pro II

Now Includes

the Rubber Bumper!

RPI Part #ATK628
OEM Part # (No OEM # Available)

SHUTTER RELEASE REPAIR KIT

• Kit includes (1) of each part as shown
Fits: Transport Assembly
Models: Peri-Pro & Peri-Pro II

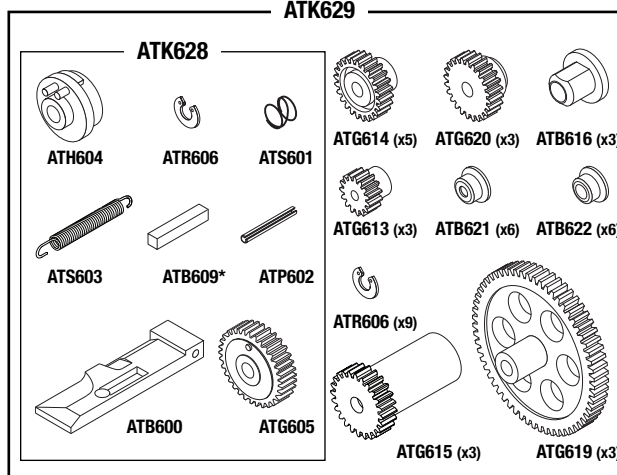

All parts shown are also sold separately!

* Secure Rubber Bumper in place using Silicone Gasket Maker 598 (RPI Part #RPS639)

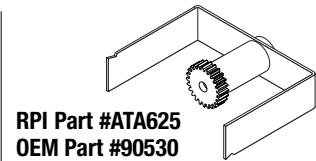

RPI Part #ATA625
OEM Part #90530

"U" TRANSFER ARM ASSEMBLY

• "U" Transfer Arm (RPI Part #ATA618) also sold separately
Fits: Transport Assembly
Models: Peri-Pro & Peri-Pro II

Now Includes

10 Per Package!

RPI Part #ATR606
OEM Part #90543

PLASTIC SNAP RING

Fits: Idler Gear Shaft and Transfer Drive Shaft
Models: Peri-Pro & Peri-Pro II

Peri-Pro III®

RPI Part #ATK663
OEM Part #94988

TRANSPORT REPAIR KIT

• Kit includes quantities as noted
Fits: Transport Assembly
Models: Peri-Pro III

RPI Part #ATK664
OEM Part # (No OEM # Available)

SHUTTER RELEASE REPAIR KIT

• Kit includes (1) of each part as shown
Fits: Transport Assembly
Models: Peri-Pro III

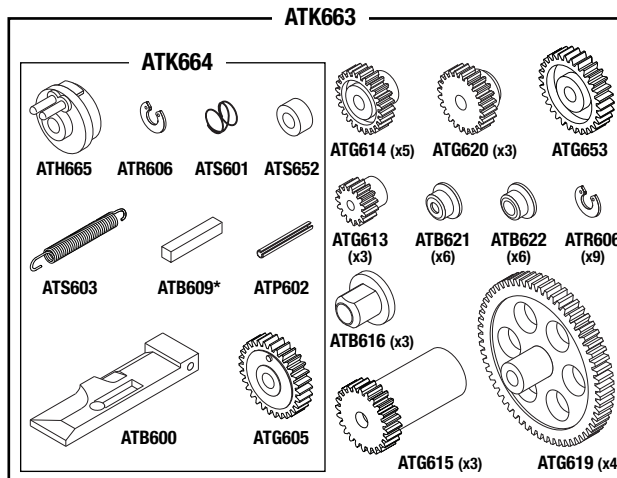

All parts shown are also sold separately!

* Secure Rubber Bumper in place using Silicone Gasket Maker 598 (RPI Part #RPS639)

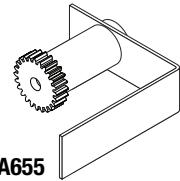

RPI Part #ATA655
OEM Part #94530

"L" TRANSFER ARM ASSEMBLY

Fits: Transport Assembly
Models: Peri-Pro III

Now Includes

10 Per Package!

RPI Part #ATR606
OEM Part #90543

PLASTIC SNAP RING

Fits: Idler Gear Shaft and Transfer Drive Shaft
Models: Peri-Pro III

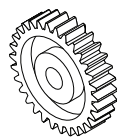

RPI Part #ATG653
OEM Part #94501

SPEED REDUCER GEAR

Fits: On top of Developer Gear on Transport
Models: Peri-Pro III

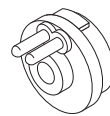

RPI Part #ATH665
OEM Part #94540

HUB & PIN ASSEMBLY

Fits: Idler Gear Shaft
Models: Peri-Pro III



RPI Part #ATS652
OEM Part # (No OEM # Available)

SPACER

Fits: Hub and Timer Gear Shaft
Models: Peri-Pro III

Dental Equipment



Models: Peri-Pro®, Peri-Pro II® & Peri-Pro III®

RPI Part #ATS673
OEM Part #94269 (Black)
 & **90262** (White no longer manufactured)

POWER SWITCH

- Color: illuminated amber lens; black body

Fits: Switch Plate

Models: Peri-Pro (S/N 15000 and above), Peri-Pro II (S/N 15143 and above) & Peri-Pro III

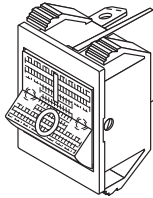

RPI Part #ATS674
New OEM Part #94977
Old OEM Part #94266

PROCESS SWITCH

- Color: illuminated green lens; black body

Fits: Switch Plate

Models: Peri-Pro II (S/N 15143 and above) & Peri-Pro III

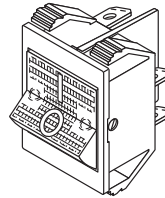

RPI Part #ATS636
OEM Part #90221

POWER SWITCH ASSEMBLY

Fits: Switch Plate

Model: Peri-Pro (Serial #14999 and below)

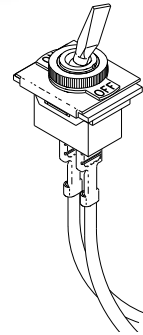

RPI Part #ATS671
OEM Part #116521

PROCESS SWITCH

- Color: white body

Fits: Switch Plate

Models: Peri-Pro II (S/N 15142 and below)

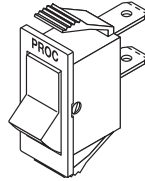

RPI Part #ATS672
OEM Part #116520

POWER SWITCH

- Color: white body

Fits: Switch Plate

Models: Peri-Pro II (S/N 15142 and below)

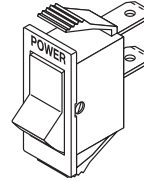

RPI Part #ATV661
OEM Part #94994

DRAIN VALVE

Fits: Peri-Pro III Base

Models: Peri-Pro III

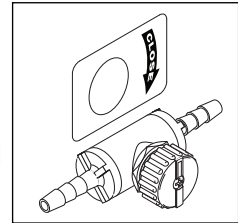

RPI Part #ATR658
OEM Part #90810

FILM RECEPTACLE

Fits: Outer Cover

Models: Peri-Pro, Peri-Pro II & Peri-Pro III

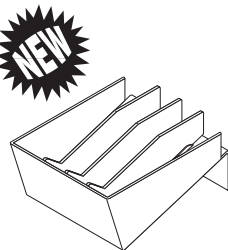

RPI Part #ATG659
OEM Part #90555

FILM INLET GRILLE

Fits: Film entrance on Transport Assembly

Models: Peri-Pro, Peri-Pro II & Peri-Pro III

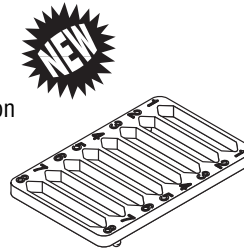

RPI Part #RPO304
OEM Part #60604

O-RING - 12/pkg

Fits: Water Tank Drain

Models: Peri-Pro III



Actual Size

RPI Part #RPH638
OEM Part #90219

FUSE HOLDER (MAIN)

Fits: Back panel

Models: Peri-Pro, Peri-Pro II & Peri-Pro III

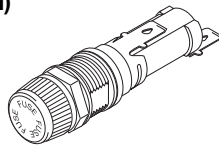

RPI Part #RPF051
OEM Part #90265

FUSE (5A, 250V) - 5/pkg

Fits: Fuse Holder

Models: Peri-Pro, Peri-Pro II & Peri-Pro III

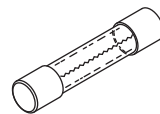

RPI Part #RPT604
OEM Part #94124

DRAIN TUBING

- Sold by the foot (reel not included)

Fits: Drain Valve

Models: Peri-Pro III

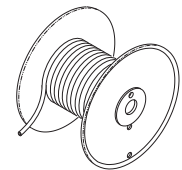

RPI Part #ATA617
OEM Part #90520

"L" TRANSFER ARM ASSEMBLY

Fits: "L" Transfer Arm

Models: Peri-Pro, Peri-Pro II & Peri-Pro III

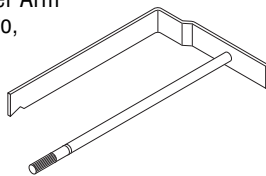

RPI Part #ATP610
OEM Part #90505

TOP PLATE PIN

Fits: Track Plate

Models: Peri-Pro, Peri-Pro II & Peri-Pro III

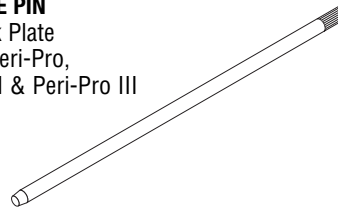

RPI Part #ATS607
OEM Part #90502

IDLER GEAR SHAFT

Fits: Transport Assembly

Models: Peri-Pro, Peri-Pro II & Peri-Pro III

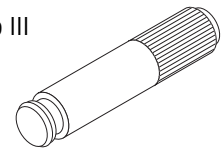

RPI Part #ATS623
OEM Part #90504

TRANSFER ARM SHAFT

Fits: Transport Assembly

Models: Peri-Pro, Peri-Pro II & Peri-Pro III

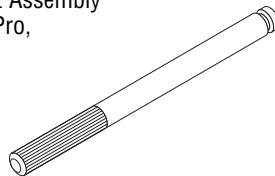

RPI Part #ATS624
OEM Part #90506

TRANSFER DRIVE SHAFT

Fits: Transport Assembly

Models: Peri-Pro & Peri-Pro II

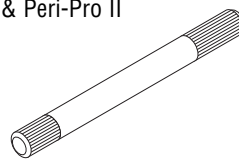

RPI Part #ATA626
OEM Part #90505

"U" TRANSFER DRIVE ASSEMBLY

- Includes all parts as shown

Fits: Transport Assembly

Models: Peri-Pro, Peri-Pro II & Peri-Pro III

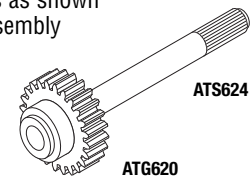

ATS624

ATG620



RPI Part #ATH634
New OEM Part #90610
Old OEM Part #90228

HEATING ELEMENT (DRYER)

- Includes mounting hardware
- Use Thermal Fuse (RPI Part #ATF651)

Fits: Dryer Section
Models: Peri-Pro & Peri-Pro II

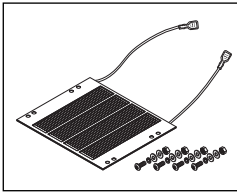

RPI Part #ATH648
OEM Part #94630

HEATING ELEMENT (DRYER)

- Includes mounting hardware
- Use Thermal Fuse (RPI Part #ATF649)

Fits: Dryer housing
Model: Peri-Pro III

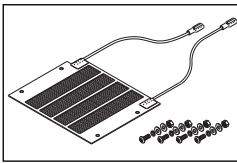

RPI Part #ATM632
OEM Part #90880

DRYER FAN & MOTOR ASSEMBLY

Fits: Base Bottom Plate
Models: Peri-Pro, Peri-Pro II & Peri-Pro III

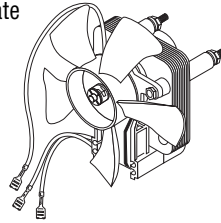

RPI Part #ATF633
OEM Part #90102

DRYER FAN BLADE

Fits: Fan and Motor Assembly
Models: Peri-Pro, Peri-Pro II & Peri-Pro III

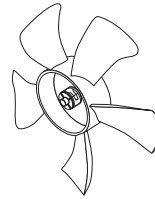

RPI Part #ATH660
OEM Part #94970

HEATER PLATE

Fits: Base Plate
Models: Peri-Pro III

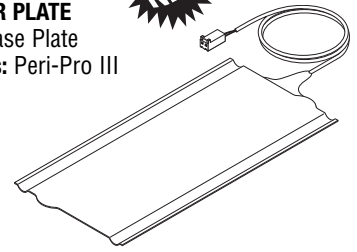

RPI Part #ATT662
OEM Part #94975

THERMISTOR PROBE

Fits: Thermistor Arm
Models: Peri-Pro III

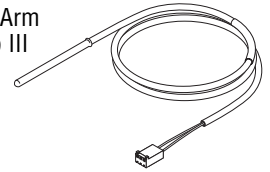

RPI Part #ATT635
OEM Part #90210

THERMOSTAT/BACKET ASSEMBLY

Model: Peri-Pro
(Serial #20479 & below)

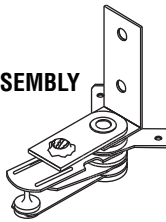

RPI Part #PCB134
OEM Part #117327

ELECTRICAL TERMINAL BUSHING

Fits: Switch Plate (Thermo Fuse)
Models: Peri Pro (Serial #20480 and above), Peri Pro II & Peri Pro III

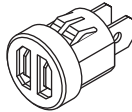

Service Tip: When the Peri-Pro III hit the market a few years ago, AirTechniques introduced a new Thermal Fuse that would work with all three models - Peri-Pro, Peri-Pro II & Peri-Pro III. However, we came to find out that this "common" fuse did not work with all three models. In fact, many of our customers found that if this fuse was used in the Peri-Pro and Peri-Pro II, it would open prematurely. As a result, here's what RPI recommends:

RPI Part #ATF651
OEM Part #90278

THERMAL FUSE (109°C)

- Use with Heating Element (Dryer) (RPI Part #ATH634)

Fits: Electrical Terminal Bushing (RPI Part #PCB134)

Model: Peri-Pro & Peri-Pro II

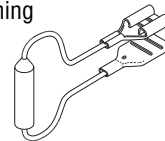

RPI Part #ATF649
OEM Part #94278

THERMAL FUSE (98°C)

- Use with Heating Element (Dryer) (RPI Part #ATH648)

Fits: Electrical Terminal bushing (RPI Part #PCB134)

Model: Peri-Pro III

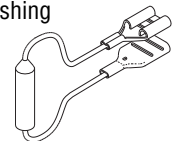

RPI Part #ATM630
OEM Part #90147

MAIN DRIVE MOTOR

Fits: Spacer Plate
Models: Peri-Pro, Peri-Pro II & Peri-Pro III

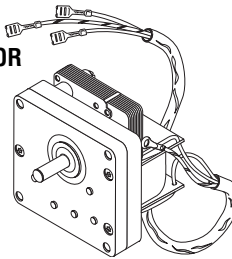

RPI Part #ATG627
OEM Part #90996

MAIN DRIVE GEAR

Fits: Motor Drive Shaft
Model: Peri-Pro II only

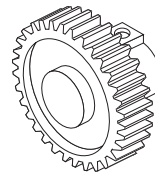

RPI Part #ATM631
OEM Part #90223

DRYER DRIVE MOTOR

Fits: Switch Plate
Model: Peri-Pro & Peri-Pro II



RPI Part #ATG611
OEM Part #90995

MAIN DRIVE GEAR

Fits: Main Drive Motor
Model: Peri-Pro only

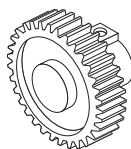

RPI Part #ATG650
OEM Part #94995

MAIN DRIVE GEAR

Fits: Drive motor
Model: Peri-Pro III only

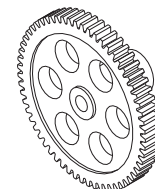

RPI Part #ATG612
OEM Part #91993

DRYER DRIVE GEAR

Fits: Dryer Drive Motor
Model: Peri-Pro & Peri-Pro II

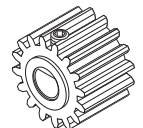

RPI PART #	OEM PART #	DESCRIPTION	PERI-PRO I	PERI-PRO II	PERI-PRO III
ATA617	90520	"L" TRANSFER ARM ASSY	•	•	•
ATA618	90564	"U" TRANSFER ARM	•	•	
ATA625	90530	"U" TRANSFER ARM ASSY	•	•	
ATA626	90550	"U" TRANSFER DRIVE ASSY	•	•	•
ATA655	94530	"L" TRANSFER ARM ASSY			•
ATB600	90548	SHUTTER RELEASE BAR	•	•	•
ATB609	90546	RUBBER BUMPER - 6/PKG	•	•	•
ATB616	90522	TRANSFER ARM BEARING - 3/PKG	•	•	•
ATB621	90523	"L" TRANSFER ARM BUSHING - 6/PKG	•	•	•
ATB622	90524	TRANSFER ARM BUSHING - 6/PKG	•	•	•
ATF633	90102	DRYER FAN BLADE	•	•	•
ATF649	94278	THERMAL FUSE (98° C)			•
ATF651	90278	THERMAL FUSE (109° C)	•	•	
ATG605	90521	TIMER GEAR	•	•	•
ATG611	90995	MAIN DRIVE GEAR	•		
ATG612	91993	DRYER DRIVE GEAR	•	•	
ATG613	90525	"L" TRANSFER ARM GEAR - 3/PKG	•	•	•
ATG614	90519	IDLER GEAR - 5/PKG	•	•	•
ATG615	90518	TRANSFER ARM GEAR - 3/PKG	•	•	•
ATG619	90517	TRANSFER ARM GEAR	•	•	•
ATG620	90516	TRANSFER GEAR - 3/PKG	•	•	•
ATG627	90996	MAIN DRIVE GEAR		•	
ATG650	94995	MAIN DRIVE GEAR			•
ATG653	94501	SPEED REDUCER GEAR			•
ATG659	90555	FILM INLET GRILLE	•	•	•
ATH604	90540	HUB & PIN ASSY	•	•	
ATH634	90610 (Old OEM Part #90228)	HEATING ELEMENT (DRYER)	•	•	
ATH648	94630	HEATING ELEMENT (DRYER)			•
ATH660	94970	HEATER PLATE			•
ATH665	94540	HUB & PIN ASSY			•
ATK628	(No OEM Part # Available)	SHUTTER RELEASE REPAIR KIT	•	•	



RPI PART #	OEM PART #	DESCRIPTION	PERI-PRO I	PERI-PRO II	PERI-PRO III
ATK629	90988	TRANSPORT REPAIR KIT	•	•	
ATK663	94988	TRANSPORT REPAIR KIT			•
ATK664	(No OEM Part # Available)	SHUTTER RELEASE REPAIR KIT			•
ATM630	90147	MAIN DRIVE MOTOR	•	•	•
ATM631	90223	DRYER DRIVE MOTOR	•	•	
ATM632	90880	DRYER FAN & MOTOR ASSY	•	•	•
ATP602	30391	SPRING PIN - 6/PKG	•	•	•
ATP610	90505	TOP PLATE PIN	•	•	•
ATR606	90543	PLASTIC SNAP RING - 10/PKG	•	•	•
ATR658	90810	FILM RECEPTACLE	•	•	•
ATS601	90545	COMPRESSION SPRING - 6/PKG	•	•	•
ATS603	90512	SHUTTER RETURN SPRING - 3/PKG	•	•	•
ATS607	90502	IDLER GEAR SHAFT	•	•	•
ATS623	90504	TRANSFER ARM SHAFT	•	•	•
ATS624	90506	TRANSFER DRIVE SHAFT	•	•	•
ATS636	90221	POWER SWITCH ASSY	1		
ATS652	(No OEM Part # Available)	SPACER - 3/PKG			•
ATS671	116521	PROCESS SWITCH		2	
ATS672	116520	POWER SWITCH		2	
ATS673	94269 (BLACK) & 90262 (WHITE)	POWER SWITCH	3	4	•
ATS674	94977 (Old OEM Part #94266)	PROCESS SWITCH		4	•
ATT635	90210	THERMOSTAT/BACKET ASSY	5		
ATT662	94975	THERMISTOR PROBE			•
ATV661	94994	DRAIN VALVE			•
PCB134	117327	ELECTRICAL TERMINAL BUSHING - 3/PKG	6	•	•
RPF051	90265	FUSE (5A, 250VAC) - 5/PKG	•	•	•
RPH638	90219	FUSE HOLDER (MAIN)	•	•	•
RPO304	60604	O-RING - 12/PKG			•
RPT604	94124	DRAIN TUBING			•

NEW PARTS ARE HIGHLIGHTED AND IN **BOLD TYPE**

1=Serial #14999 and below
 5=Serial #20479 and below

2= Serial # 15142 and below
 6=Serial #20480 and above

3=Serial #15000 and above

4=Serial #15143 and above

ADDRESS SERVICES REQUESTED

PRESORTED STANDARD
 U.S. POSTAGE PAID
 VAN NUYS, CA
 PERMIT NO. 2399

LOOK INSIDE!
NEW & EXISTING PARTS
TO FIT AIR TECHNIQUES
PERI-PRO, PERI-PRO II & PERI-PRO III.