



New parts to fit Midmark®•Ritter®

UltraClave® M9, M9D, M11 & M11D Sterilizers!



RPI Part #MIA137
OEM Part #029-2755-00 & 002-1362-00

FILL/VENT VALVE ASSEMBLY

- Material: Brass body and fittings
- 120VAC, 50/60 Hz. FWR, 14W
- Includes all parts as shown

Fits: Chassis

Models: See RPI website for Serial # prefix breakdown of the models this part fits: M9, M9D, M11 & M11D

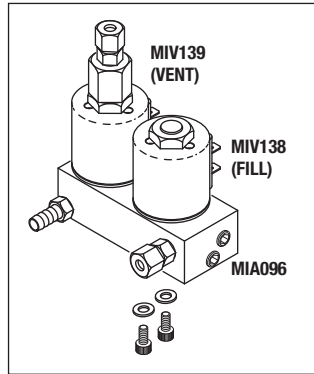

RPI Part #MIA096
OEM Part #029-2755-00 (Manifold Only) & 002-1362-00 (Manifold Only)

MANIFOLD BLOCK ASSEMBLY

- Material: Brass body and fittings
- Includes all parts as shown
- Also included in: Fill/Vent Valve Assembly (RPI Part #MIA137)

Fits: Fill/Vent Valve Assembly

Models: See RPI website for Serial # prefix breakdown of the models this part fits: M9, M9D, M11 & M11D

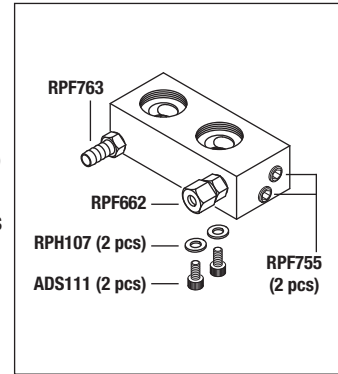

RPI Part #MIV138
OEM Part #002-1360-00 & 014-0420-02

SOLENOID VALVE (FILL)

- Material: Viton seals
- 120VAC, 50/60 Hz. FWR, 14W
- Also included in: Fill/Vent Valve Assembly (RPI Part #MIA137)

Fits: Manifold Block Assembly

Models: See RPI website for Serial # prefix breakdown of the models this part fits: M9, M9D, M11 & M11D

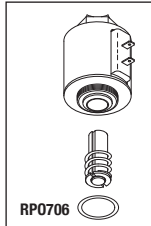

RPI Part #RCK113
OEM Part #014-0236-11

SOLENOID VALVE REPAIR KIT

- Material: Viton seals
- Includes all parts as shown
- Also included in: Solenoid Valve (Fill) (RPI Part #MIV138)

Fits: Solenoid Valve - Fill (KIP only)

Models: See RPI website for Serial # prefix breakdown of the models this part fits: M9, M9D, M11 & M11D

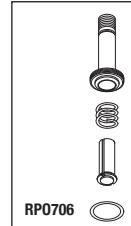

RPI Part #RCC114
OEM Part #014-0236-10

COIL

- 1/4" tabs
- 180°C, 3.24-3.96 MEG Ω
- 120VAC; 50/60 Hz. FWR, 14W
- Also included in: Solenoid Valve (Fill) (RPI Part #MIV138) & Solenoid Valve (Vent) (RPI Part #MIV139)

Fits: Solenoid Valve - Fill or Vent (KIP only)

Models: See RPI website for Serial # prefix breakdown of the models this part fits: M9, M9D, M11 & M11D

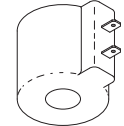

Need Repair Kit? →

Need Coil? →



RPI Part #MIV139
OEM Part #002-1361-00 & 014-0420-03

SOLENOID VALVE (VENT)

- Material: Viton seals
- 120VAC, 50/60 Hz. FWR, 14W
- Includes all parts as shown
- Also included in: Fill/Vent Valve Assembly (RPI Part #MIA137)

Fits: Manifold Block Assembly

Models: See RPI website for Serial # prefix breakdown of the models this part fits: M9, M9D, M11 & M11D

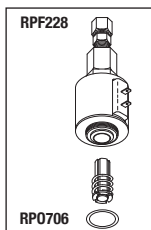

RPI Part #MIK110
OEM Part # (No OEM Part # Available)

SOLENOID VALVE REPAIR KIT

- Material: Viton seals
- Includes all parts as shown
- Redesigned - Now includes bonnet!
- Also Included in: Solenoid Valve (Vent) (RPI Part #MIV139)

Fits: Solenoid Valve - Vent (KIP only)

Models: See RPI website for Serial # prefix breakdown of the models this part fits: M9, M9D, M11 & M11D

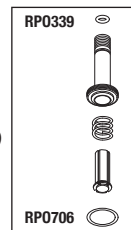

RPI Part #RCC114
OEM Part #014-0236-10

COIL

- 1/4" tabs
- 180°C, 3.24-3.96 MEG Ω
- 120VAC; 50/60 Hz. FWR, 14W
- Also included in: Solenoid Valve (Fill) (RPI Part #MIV138) & Solenoid Valve (Vent) (RPI Part #MIV139)

Fits: Solenoid Valve - Fill or Vent (KIP only)

Models: See RPI website for Serial # prefix breakdown of the models this part fits: M9, M9D, M11 & M11D

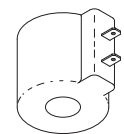

Need Repair Kit? →

Need Coil? →



replacement parts industries, inc.

CALL (800) 221-9723 • FAX (818) 882-7028 • EMAIL order@rpiparts.com • WEBSITE www.rpiparts.com

The above parts are manufactured by Replacement Parts Industries, Inc. to fit Midmark®•Ritter® equipment. All product names used in this document are trademarks or registered trademarks of their respective holders. Web 02/12

Table Top Sterilizers

Models: UltraClave® M9, M9D, M11 & M11D



RPI Part #MIA147
OEM Part #015-1550-00



DISPLAY ASSEMBLY

- Includes: Display (LCD) (RPI Part #MID148), Display Driver PC Board (RPI Part #MIB149), Ribbon Cable (RPI Part #MIC150), & (4 pcs) Screw (#6-32 x 3/8") (RPI Part #AIS170)
- Also available: Suppression Core (RPI Part #RPC762)

Fits: Top Cover (newer style units)

Models: See RPI website for Serial # prefix breakdown of the models this part fits: M9, M9D, M11 & M11D

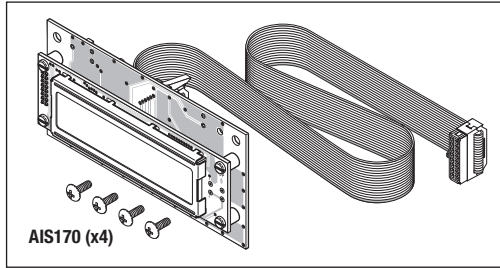

AIS170 (x4)

RPI Part #MID148

OEM Part # (No OEM Part # Available)



DISPLAY (LCD)

- Includes: (4) Nylon® screws, (4) Nylon® spacers, (4) Nylon® nuts and (4) Nylon® washers
- Also included in: Display Assembly (RPI Part #MIA147)

Fits: Display Assembly (newer style units)

Models: See RPI website for Serial # prefix breakdown of the models this part fits: M9, M9D, M11 & M11D

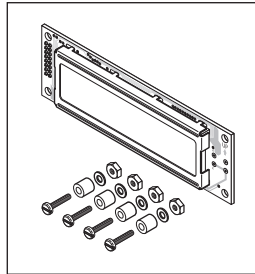

RPI Part #MIB149

OEM Part # (No OEM Part # Available)



DISPLAY DRIVER PC BOARD

- Also included in: Display Assembly (RPI Part #MIA147)
- This PC Board is HumiSeal® conformal coated

Fits: Display Assembly (newer style units)

Models: See RPI website for Serial # prefix breakdown of the models this part fits: M9, M9D, M11 & M11D

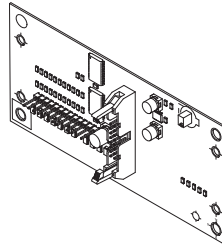

RPI Part #MIC150

OEM Part #015-1550-01



RIBBON CABLE (DISPLAY)

- Size: ~18" lg.
- 16 Conductor Cable
- Also included in: Display Assembly (RPI Part #MIA147)
- Also available: Suppression Coil (RPI Part #RPC762)

Fits: Display Assembly (newer style units)

Models: See RPI website for Serial # prefix breakdown of the models this part fits: M9, M9D, M11 & M11D

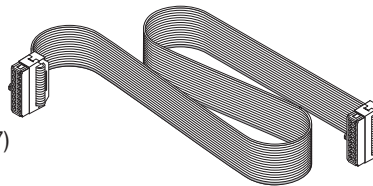

RPI Part #RPC762

OEM Part #015-1641-00



SUPPRESSION CORE

- Size: 1.95" W x 1.27" lg. x .64" thk
- Material: Plastic covered ferrite
- Snap action designed for flat cables up to 1.0" wide
- Also available: Ribbon Cable (Display) (RPI Part #MIC150)

Fits: Display Ribbon Cable (newer style units)

Models: See RPI website for Serial # prefix breakdown of the models this part fits: M9, M9D, M11 & M11D

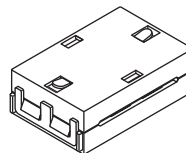

AIS170 (6 PCS)

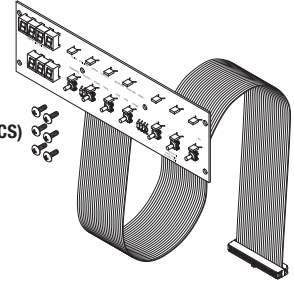

RPI Part #MIB115

OEM Part #002-0369-02, 015-0646-00 (Cable only) & **002-0369-00** (Display PC Board only)

DISPLAY PC BOARD

- Includes all parts as shown
- This PC Board is HumiSeal® conformal coated

Fits: Top Cover (older style units)

Models: See RPI website for Serial # prefix breakdown of the models this part fits: M9, M9D, M11 & M11D



RPI Part #MIG116

OEM Part #053-0454-00

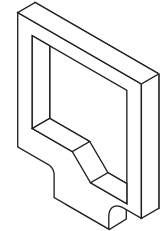

DISPLAY PC BOARD GASKET

- Material: Black foam rubber with adhesive backing

Fits: Top Cover (older style units)

Models: See RPI website for Serial # prefix breakdown of the models this part fits: M9, M9D, M11 & M11D



RPI Part #AIS170

OEM Part # (No OEM Part # Available)

SCREW (#6-32 x 3/8)

- 2 per package
- Material: Stainless steel supplied with pre-applied thread locker
- Size: #6-32 x 3/8" lg.
- Phillips Truss Head Screw
- Also included in: Display PC Board (RPI Part #MIB115) and Display Assembly (RPI Part #MIA147)

Fits: Top Cover

Models: M9, M9D, M11, M11D



Table Top Sterilizers

Models: UltraClave® M9, M9D, M11 & M11D

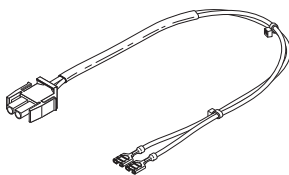

RPI Part #MIH135
OEM Part #015-0657-00

HEATER HARNESS

- Size: ~14.00" lg.
- Fits:** PC Board to Heater (older style units only)
- Models:** See RPI website for Serial # prefix breakdown of the models this part fits: M9, M9D, M11 & M11D

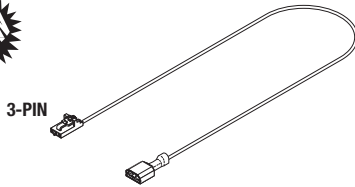

RPI Part #MIH136
OEM Part #015-0654-00

WATER LEVEL SENSOR HARNESS

- Size: ~14.75" lg.
- Fits:** PC Board to Water Level Sensor (older style units only)
- Models:** See RPI website for Serial # prefix breakdown of the models this part fits: M9, M9D, M11 & M11D

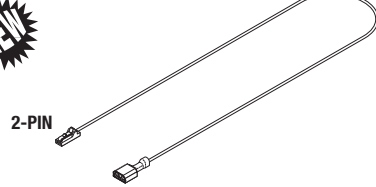

RPI Part #MIH145
OEM Part #015-1522-00

WATER LEVEL SENSOR HARNESS

- Size: ~18.00" lg.
- Fits:** PC Board to Water Level Sensor (newer style units only)
- Models:** See RPI website for Serial # prefix breakdown of the models this part fits: M9, M9D, M11 & M11D

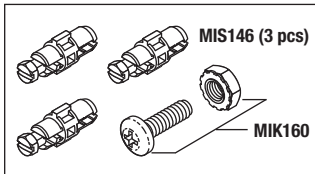

RPI Part #MIK159
OEM Part # (No OEM Part # Available)

PCB MOUNTING KIT

- Includes all parts as shown
- Fits:** PC Boards to Mounting Plate
- Models:** See RPI website for Serial # prefix breakdown of the models this part fits: M9, M9D, M11 & M11D

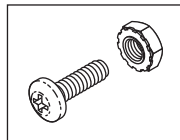

RPI Part #MIK160
OEM Part #040-0010-46 (Screw only) & 041-0010-04 (Lock nut only)

GROUND SCREW KIT

- Includes: Phillips Pan Head Screw #10-24 x 1/2" lg. & Lock Nut #10-24
- Fits:** PC board to Mounting Bracket
- Models:** See RPI website for Serial # prefix breakdown of the models this part fits: M9, M9D, M11 & M11D

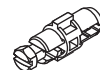

RPI Part #MIS146
OEM Part #053-0295-01

STANDOFF

- 3 per package
- Quarter Turn Style; provides 3/16" spacing
- Fits:** PC Boards to Mounting Plate
- Models:** See RPI website for Serial # prefix breakdown of the models this part fits: M9, M9D, M11 & M11D

Don't forget ... RPI also carries these parts and more to fit Midmark•Ritter M9, M9D, M11 & M11D

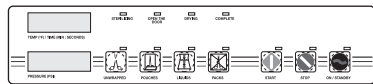

RPI Part #MIP097
OEM Part #061-0531-00

DISPLAY OVERLAY

- Fits:** Top Cover (older style units)
- Models:** See RPI website for Serial # prefix breakdown of the models this part fits: M9D & M11D

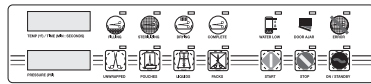

RPI Part #MIP098
OEM Part #061-0272-01

DISPLAY OVERLAY

- Fits:** Top Cover (older style units)
- Models:** See RPI website for Serial # prefix breakdown of the models this part fits: M9 & M11

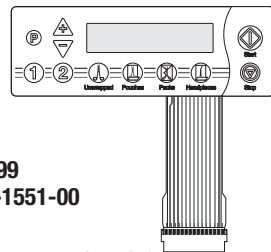

RPI Part #MIP099
OEM Part #015-1551-00

TOUCH PAD

- Fits:** Top Cover (newer style units)
- Models:** See RPI website for Serial # prefix breakdown of the models this part fits: M9, M9D, M11 & M11D

RPI Part #RPF049
OEM Part #015-0346-08

FUSE-PRINTER (3A, 250V)

- 5 per package
- AGC; Glass; 1/4" dia. x 1-1/4" lg.
- Fast-Acting
- Fits:** PC Board
- Models:** M9, M9D, M11 & M11D

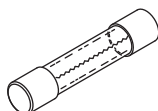

RPI Part #RPF281
OEM Part #015-0346-07

FUSE (15A, 250V)

- 5 per package
- 3AB; Ceramic; 1/4" dia. x 1-1/4" lg.
- Fast-Acting
- Fits:** PC Board/Fuse Holder
- Models:** M9, M9D, M11 & M11D

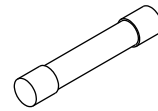

Table Top Sterilizers

Models: UltraClave® M9, M9D, M11 & M11D



RPI Part #MIA092

OEM Part #029-3041-00, 050-5459-00 (Bracket only)
& 015-1430-00 (Thermostat only)



FAN THERMOSTAT ASSEMBLY

- Material: Stainless steel bracket and hardware
- Closes at 130°F, Opens at 101°F
- 250VAC, 0.5A

Fits: Door Frame (newer style units)

Models: See RPI website for Serial # prefix breakdown of the models this part fits: M9, M9D, M11D, M11D

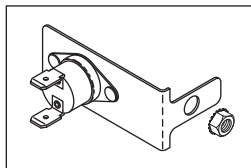

RPI Part #MIB140

OEM Part #053-0630-01



STEAM BLOCK

- Material: White plastic encapsulated foam
- Size: ~12.0" lg.

Fits: Door Frame (older style units)

Models: See RPI website for Serial # prefix breakdown of the models this part fits: M11, M11D

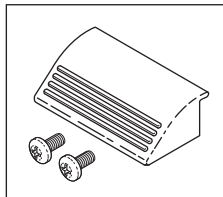
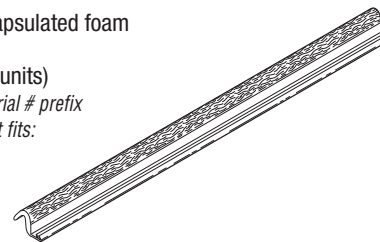

RPI Part #MIH161
OEM Part #053-0912-00

DOOR HANDLE

- Includes: (2) Screw (#10-24 X .375" lg.)
- Fits:** Door (older style units)
- Models:** See RPI website for Serial # prefix breakdown of the models this part fits: M9

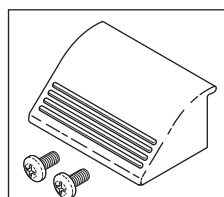

RPI Part #MIH162
OEM Part #053-0909-00

DOOR HANDLE

- Includes: (2) Screw (#10-24 X .375" lg.)
- Fits:** Door (older style units)
- Models:** See RPI website for Serial # prefix breakdown of the models this part fits: M11

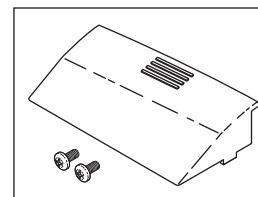

RPI Part #MIH163
OEM Part #053-1253-00

DOOR HANDLE

- Includes: (2) Screw (#10-24 X .375" lg.)
- Fits:** Door (newer style units)
- Models:** See RPI website for Serial # prefix breakdown of the models this part fits: M9, M9D, M11 & M11D



RPI Part #RPF763
OEM Part #014-0347-00

BARB

- 2 per package
 - Material: Brass
 - Size: 3/8" barb to 1/4" MPT
 - Also included in: Manifold Block Assembly (RPI Part #MIA096)
- Fits:** Manifold Block Assembly
- Models:** See RPI website for Serial # prefix breakdown of the models this part fits: M9, M9D, M11 & M11D

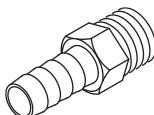

RPI Part #ADS111
OEM Part # (No OEM Part # Available)

SOCKET HEAD CAP SCREW

- 25 per package
 - Material: Stainless steel
 - Size: #6-32 x 3/8" lg.
 - Also included in: Manifold Block Assembly (RPI Part #MIA096) & Socket Head Cap Screw Kit (RPI Part #ADK110)
- Fits:** Manifold Block Assembly
- Models:** See RPI website for Serial # prefix breakdown of the models this part fits: M9, M9D, M11 & M11D



RPI Part #RPF755
OEM Part # (No OEM Part # Available)

PLUG

- 4 per package
 - Material: Brass
 - Size: 1/8" MPT
 - Also included in: Manifold Block Assembly (RPI Part #MIA096)
- Fits:** Manifold Block Assembly
- Models:** See RPI website for Serial # prefix breakdown of the models this part fits: M9, M9D, M11 & M11D



RPI Part #RPF662
OEM Part #014-0183-02

MALE CONNECTOR

- Material: Brass
 - Size: 1/4" Tubing x 3/8" MPT
 - Includes: Compression Nut (RPI Part #RPF222) & Compression Sleeve (RPI Part #RPF218)
 - Also included in: Manifold Block Assembly (RPI Part #MIA096)
- Fits:** Fill/Vent Valve Assembly
- Models:** See RPI website for Serial # prefix breakdown of the models this part fits: M9, M9D, M11 & M11D

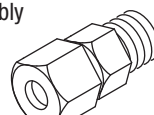

RPI Part #RPH107
OEM Part # (No OEM Part # Available)

#6 FLAT WASHER

- 50 per package
 - Material: Stainless steel
 - Also included in: Manifold Block Assembly (RPI Part #MIA096) & Hardware Kit (RPI Part #RPK402)
- Fits:** Manifold Block Assembly
- Models:** See RPI website for Serial # prefix breakdown of the models this part fits: M9, M9D, M11 & M11D



RPI Part #RPF228
OEM Part # (No OEM Part # Available)

MALE CONNECTOR

- 5 per package
 - Material: Brass
 - Size: 3/16" Tubing x 1/4" MPT
 - Also included in: Solenoid Valve (Vent) (RPI Part #MIV139) & Fill/Vent Valve Assembly (RPI Part #MIA137)
- Fits:** Solenoid Valve (Vent)
- Models:** See RPI website for Serial # prefix breakdown of the models this part fits: M9, M9D, M11 & M11D

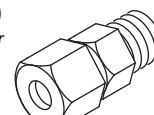

replacement parts industries, inc.

CALL (800) 221-9723 • FAX (818) 882-7028 • EMAIL order@rpiparts.com • WEBSITE www.rpiparts.com