

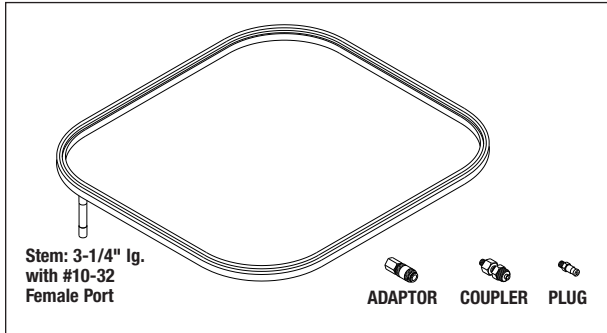

New Parts and More to fit Steris® System 1E® Sterile Processing Systems!



RPI Part #SSS001
OEM Part #201153/200213

INFLATABLE CHAMBER SEAL

- Fabric reinforced EPDM
- Size: 21.57" x 23.06" outside dim.
- Includes all parts as shown

Fits: Chamber Frame Assembly

Model: System 1E



SSS001
CROSS SECTION
SHOWN ACTUAL SIZE

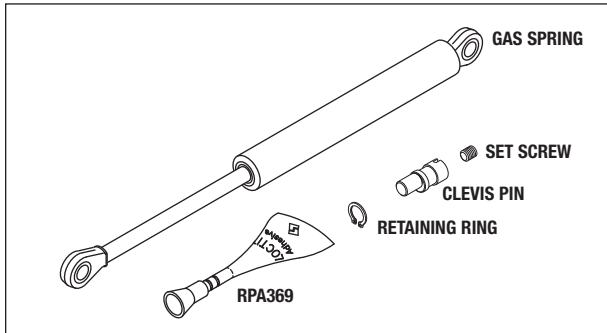

RPI Part #SSK010
OEM Part #200056

GAS SPRING ASSEMBLY

- Extension Force: 594 N (134 LBF)
- Includes all parts as shown

Fits: Lid Assembly

Model: System 1E

RPI Part #SST033
OEM Part #500019

LS-1 THERMAL CUT OFF SWITCH

- Opens @ 79°C (174°F); Manual reset
- 1/4" tabs
- Includes: (One tube) Heat Sink Compound (RPI Part #RPC464)

Fits: Heater Housing

Model: System 1E

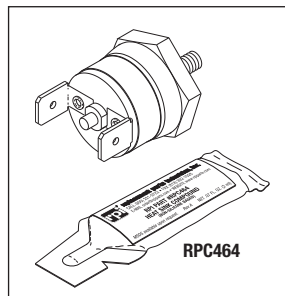

RPI Part #SSF013
OEM Part #A1501

PREFILTER CARTRIDGE ("A" FILTER)

- 0.2 micron
- Size: 2.68" OD x 9.59" lg.
- Silicone O-ring
- For use in single prefilter system or as filter "A" in dual prefilter system
- Included in: Filter Package ("A" & "B") (RPI Part #SSP057)

Model: System 1E

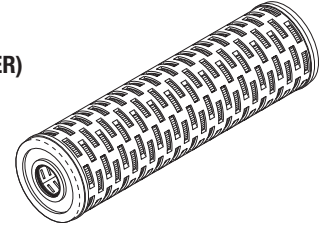

RPI Part #SSF052
OEM Part #A1562

PREFILTER CARTRIDGE ("B" FILTER)

- 0.6 / 0.1 micron dual wrap filter media
- Size: 2.55" OD x 10" lg.
- EPDM O-rings
- Included in: Filter Package ("A" & "B") (RPI Part #SSP057)

Fits: External Water Filter Assembly

Model: System 1E

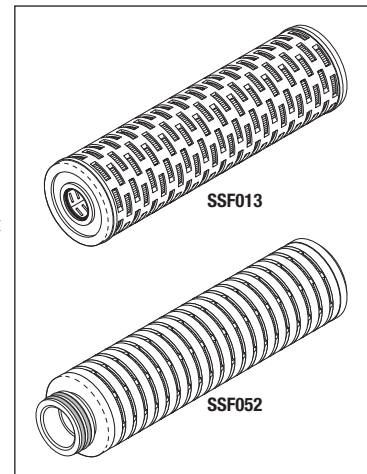
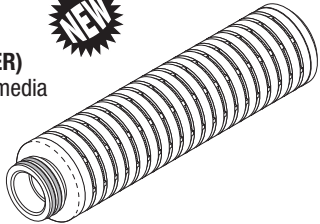

RPI Part #SSP057
OEM Part #A1567

FILTER PACKAGE ("A" & "B")

- Includes all parts as shown

Fits: Pre-Filter Assembly

Model: System 1E

RPI Part #SSF011
OEM Part #A1503

STERILE AIR FILTER

- 0.2 micron
- Size: 2.60" OD x 3.80" lg.
- Ports: 3/8" FPT
- 75mm filter media capsule

Fits: Float Block Assembly Air Intake Line

Model: System 1E

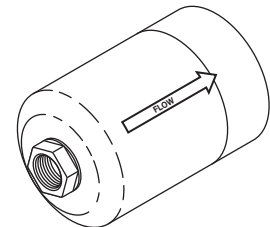

Scope Processing Systems

Model: System 1E®

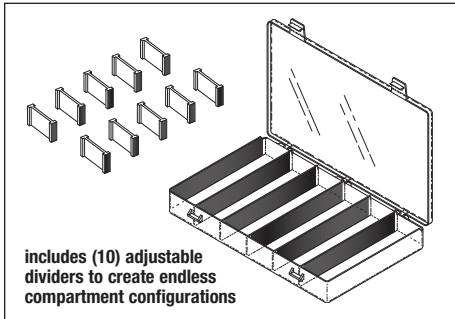

includes (10) adjustable dividers to create endless compartment configurations

RPI Part #RPC616
OEM Part # (No OEM Part # Available)

STORAGE CASE

- (6) standard compartments (1-11/16" w x 6-3/16" lg.) with (10) adjustable dividers
 - 10-1/2" w x 6-3/16" lg. x 1-9/16" d
 - Material: Translucent polypropylene
- Model:** System 1E

RPI Part #RPL615
OEM Part #400035

O-RING LUBRICANT

- 2 oz. tube
 - Non-Toxic; Super-O-Lube® made by Parker
 - Temperature Range: -65° to 400° F
 - Included in O-Ring Kit for Servicing Steris® System 1E® Sterile Processing System (RPI Part #SSK050)
 - Can be used on Silicone and non-silicone rubber materials
- Model:** System 1E

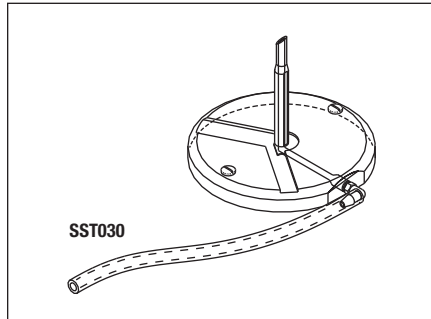
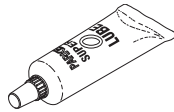

SST030

RPI Part #SSA029
OEM Part #A1600

STERILANT ASPIRATOR ASSEMBLY

- Material: 3-1/4" OD clear Lexan™
 - Includes: (5-5/8" lg. piece) Silicone Tubing (RPI Part #SST030)
- Fits:** Instrument Trays
Model: System 1E

RPI Part #SST030
OEM Part #

(No OEM Part # Available)

SILICONE TUBING

- .125" ID x .250" OD
 - Sold by the foot, reel **NOT** included
 - Medical grade translucent silicone
- Fits:** Sterilant Aspirator Assembly and 1/8" Barb
Model: System 1E

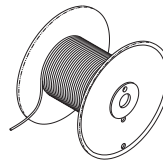

RPI Part #SSB042
OEM Part #100209

DRAIN VALVE BUSHING

- Size: 2.44" OD x .75" tall
 - Closed cell silicone sponge
- Fits:** Drain Section on All Trays
Model: System 1E

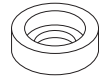

RPI Part #SSV017
OEM Part #200188

SOLENOID VALVE ASSEMBLY (SOL-1)

- 24VAC, 60Hz, 6W
- Fits:** Air Manifold Assembly
Model: System 1E

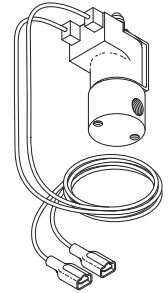

RPI Part #SSV019
OEM Part #200189

SOLENOID VALVE ASSEMBLY (SOL-2, 3 & 4)

- 24AC, 60Hz, 6W
 - SOL-2 Seal Release
 - SOL-3 Circulation Pinch Valve
 - SOL-4 Drain Pinch Valve
- Fits:** Air Manifold Assembly
Model: System 1E

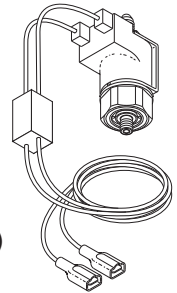

RPI Part #SSV024
OEM Part #200154

DUAL WATER INLET VALVE (SOL-5 & 7)

- 24VAC: N. C.
- Fits:** Mounts to Machine Chassis
Model: System 1E

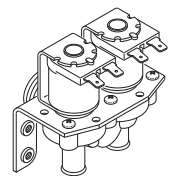

RPI Part #SSS007
OEM Part #400420

PINCH VALVE SLEEVE

- Size: 1.73" OD x 2.39" tall
 - Material: Red silicone
- Fits:** Pinch Valves
Model: System 1E

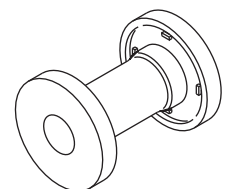

RPI Part #SSK050
OEM Part # (No OEM Part # Available)

O-RING KIT FOR SERVICING STERIS® SYSTEM 1E® STERILE PROCESSING SYSTEM

- Includes: 15-compartment Storage Case (RPI Part #RPC616), O-ring Lubricant (RPI Part #RPL615) and O-ring Removal Tools (RPI Part #RPK581)
- O-rings are also sold separately in reorder quantities

Model: System 1E

Price (Qty 1-9): \$86.50

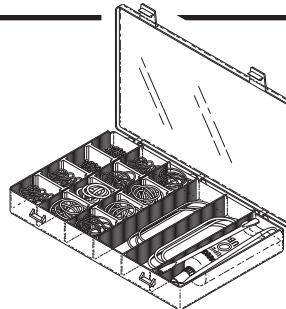

RPI PART #	STERIS PART #	X-SEC	ID	OD	MATERIAL	DURO	KIT QTY	REORDER QTY
RP0307	450617	.070	.114	.254	EPDM	70	12	12
RP0354	450609	.070	.926	1.066	Silicone	70	12	6
RP0388	450610	.070	.426	.566	Silicone	70	12	6
RP0389	450608	.103	1.049	1.255	Silicone	70	12	6
RP0390	450614	.070	1.114	1.254	Silicone	70	12	6
RP0450	450621	.051	.547	.649	Silicone	70	12	6
RP0605	450600	.103	1.174	1.380	Silicone	70	12	12
RP0606	450601	.139	.859	1.137	Silicone	70	12	12
RP0607	450605	.070	1.239	1.379	Silicone	70	12	12
RP0608	450606	.070	.489	.629	Silicone	70	12	12
RP0609	450611	.070	.114	.254	Silicone	70	12	12
RP0610	450612	.103	.924	1.130	Silicone	70	12	12
RP0612	450620	3mm	80mm	86mm	Silicone	60	3	3
RP0613	450622	.139	3.484	3.762	Viton	70	3	3



RPI Part #SSP054
OEM Part #P764335-393
PM PACKAGE (CHECK VALVE)

- Includes all parts as shown
- All parts in kit also sold separately

Model: System 1E

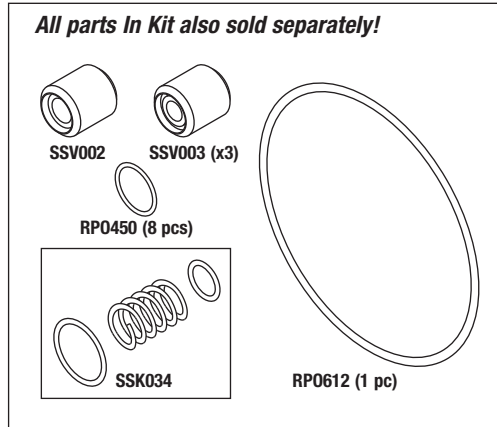

RPI Part #SSV002
OEM Part #400345

CHECK VALVE (CK-1)

- Size: .614" OD x .640" lg.
- Material: Stainless steel
- Also available: O-Ring (RPI Part #RPO450)

Fits: Air Inlet Valve
Model: System 1E

Included In PM Package (Check Valve) (RPI Part #SSP054)!

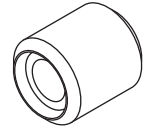

RPI Part #SSV003
OEM Part #400510

CHECK VALVE (CK-2, 3 & 11)

- Size: .614" OD x .640" lg.
- Material: Stainless steel
- Also available: O-Ring (RPI Part #RPO450)

Fits: Float Block Drain Assembly
Model: System 1E

Included In PM Package (Check Valve) (RPI Part #SSP054)!

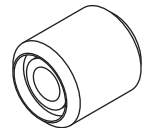

RPI Part #SSK006
OEM Part #200226
CHECK VALVE KIT

- Includes all parts as shown
- Used on units with brass Kepner Check Valve

Model: System 1E

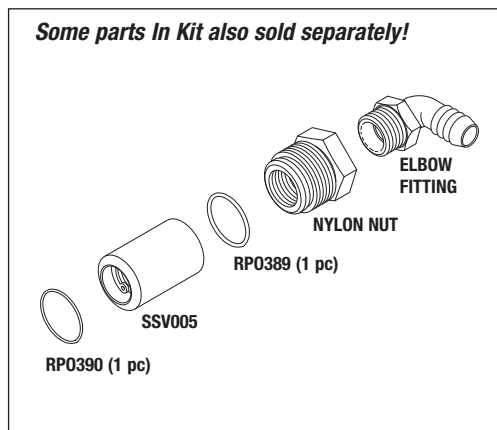

RPI Part #SSV005
OEM Part #400368

CHECK VALVE (CK-4)

- Size: 1.242" OD x 1.938" lg.
- Material: Stainless steel
- Includes: (1 pc) O-Ring (RPI Part #RPO353) - installed
- Also available: O-Rings (RPI Part #'s RPO389 & RPO390)

Fits: Sterile Filter Housing
Model: System 1E

Included In Check Valve Kit (RPI Part #SSP054)!

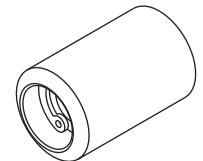

RPI Part #SSK008
OEM Part #400696
CHECK VALVE REBUILD KIT (CK-8)

- Includes all parts as shown

Fits: Drain Valve
Model: System 1E

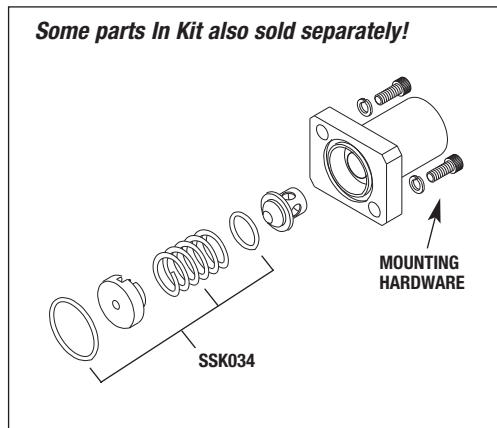

RPI Part #SSV055
OEM Part #400774

CHECK VALVE (CK-5, 6, 7)

- Size: .623" OD x .574" lg.
- Material: Stainless steel body; EPDM O-rings
- Includes all parts as shown

Fits: Air Manifold
Model: System 1E

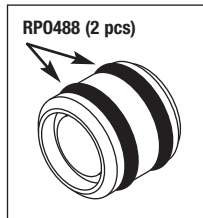

RPI Part #SSK034
OEM Part #200696
CHECK VALVE REPAIR KIT (CK-8)

- Includes all parts as shown
- Material: Stainless steel spring; Buna N (Nitrile) O-rings

Fits: CK-8 Check Valve
Model: System 1E

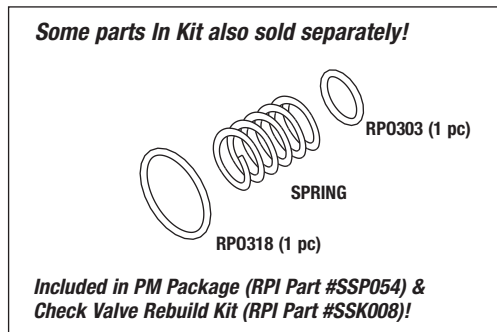

RPI Part #SSV056
OEM Part #400219

CHECK VALVE (ANTI-SYPHON) (CK-10)





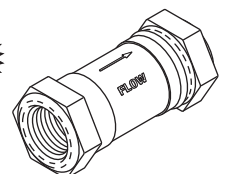

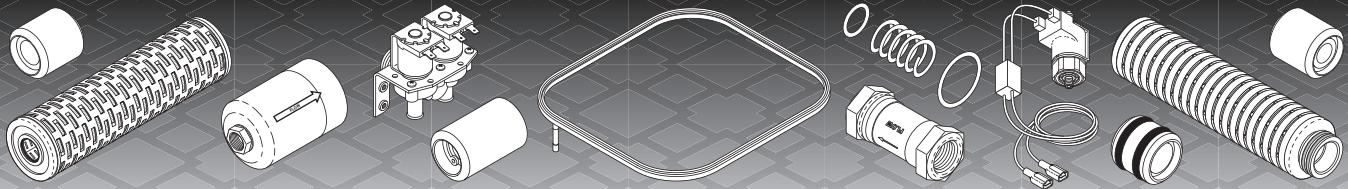
- Cracking pressure: 0.11 PSI
- Ports: 1/4" FPT
- Material: PVDF body; Silicone seal
- Size: 3/4" hex x 1-3/4" lg.

Fits: Vent Line: Drip Pan to Drain Block
Model: System 1E





RPI is Your Best Source for Parts to fit Steris® System 1E® Sterile Processing Systems!

RPI Part #	OEM Part #	Description
RPC464	<i>(No OEM Part # Available)</i>	Heat Sink Compound - 5 per package
RPC616	<i>(No OEM Part # Available)</i>	16 Adjustable Compartment Storage Case
RPL615	400035	O-Ring Lubricant
RPO303	<i>(No OEM Part # Available)</i>	O-Ring - 12 per package
RPO318	<i>(No OEM Part # Available)</i>	O-Ring - 12 per package
RPO354	450609	Air Valve O-Ring - 6 per package
RPO388	450610	O-Ring - 6 per package
RPO389	450608	O-Ring - 6 per package
RPO390	450614	O-Ring - 6 per package
RPO450	450621	O-Ring - 6 per package
RPO605	450600	O-Ring - 12 per package
RPO606	450601	O-Ring - 12 per package
RPO607	450605	O-Ring - 12 per package
RPO608	450606	O-Ring - 12 per package
RPO609	450611	O-Ring - 12 per package
RPO610	450612	O-Ring - 12 per package
RPO612	450620	O-Ring - 3 per package
RPO613	450622	O-Ring - 3 per package
SSA029	A1600	Sterilant Aspirator Assembly
SSB042	100209	Drain Valve Bushing
 SSF011	A1503	Sterile Air Filter
SSF013	A1501	Pre-filter Cartridge ("A" Filter)
 SSF052	A1562	Pre-filter Cartridge ("B" Filter)
SSK006	200226	Check Valve Kit (CK-4)
SSK008	400696	Check Valve Rebuild Kit (CK-8)
SSK010	200056	Gas Spring Assembly
SSK034	200696	Check Valve Repair Kit (CK-8)
SSK050	<i>(No OEM Part # Available)</i>	O-Ring Kit
 SSP054	P764335-393	PM Package (Check Valve)
 SSP057	A1567	Filter Package ("A" & "B")
SSS001	201153, 200213	Inflatable Chamber Seal
SSS007	400420	Pinch Valve Sleeve
SST030	<i>(No OEM Part # Available)</i>	Silicone Tubing - sold by the foot
SST033	500019	LS-1 Thermal Cut Off Switch
SSV002	400345	Check Valve (CK-1)
SSV003	400510	Check Valve (CK-2 & 3)
SSV005	400368	Check Valve (CK-4)
SSV017	200188	Solenoid Valve Assembly (Sol-1)
SSV019	200189	Solenoid Valve Assembly (Sol-2, 3 & 4)
SSV024	200154	Dual Water Inlet Valve (Sol-5 & 7)
 SSV055	400774	Check Valve (CK-5, 6, 7)
 SSV056	400219	Check Valve (Anti-Syphon) (CK-10)