



New Parts to fit Stryker® 900 Series Cast Cutters

RPI Part #RP0335
OEM Part #45-29

*O-Ring shapes
to fit Housing*

O-RING (12/pkg)
• 1.489" ID x 1.629" OD x .070" C/S
Models: 940 & 941

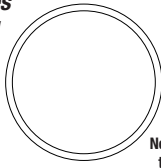

Not shown
to scale

RPI Part #RPL680
OEM Part # (No OEM Part # Available)

BEARING GREASE (5/pkg)
Models: 940 & 941



Includes (5) 0.68 fl. oz. packs

RPI Part #RPT700
OEM Part # (No OEM Part # Available)

T-15 TORX WRENCH
Models: 940 & 941

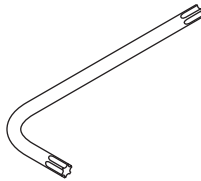

RPI Part #STA040
OEM Part #12-24, 21-129, 45-29, 50-33,
940-1-115, 940-1-118, 940-1-125

OUTPUT DRIVE ASSEMBLY

• Includes Shaft Link (RPI Part #STL016) already installed
Models: 940 & 941

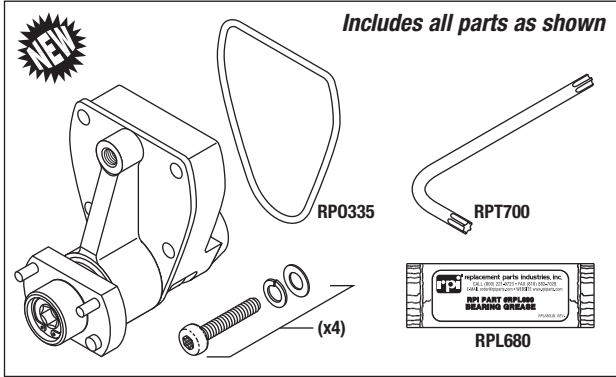

Includes all parts as shown

RPI Part #STB039
OEM Part # (No OEM Part # Available)

POWER SUPPLY PCB
• 115VAC
• Also available, Fuse
(RPI Part #RPF665)
Models: 940

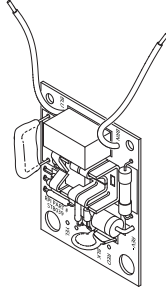

RPI Part #RPF665
OEM Part # (No OEM Part # Available)
AXIAL LEAD FUSE (2-1/2A) (5/pkg)
Models: 940

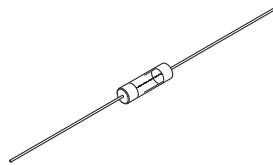

RPI Part #STF036
OEM Part # (No OEM Part # Available)
THERMAL FUSE (104°C)
Models: 940 & 941

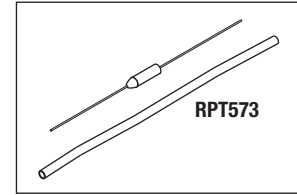

RPT573

RPI Part #STB031
OEM Part # (No OEM Part # Available)
FRONT BEARING
Models: 940 & 941



RPI Part #STK030
OEM Part #28-111 (Retaining Ring only),
11-275 (Washers only), 81-118 (Needle
Bearing only)
ROLLER BEARING KIT
Models: 940 & 941

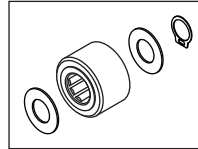

RPI Part #STB032
OEM Part # (No OEM Part # Available)
REAR BEARING
Models: 940 & 941



RPI Part #STA028
OEM Part # (No OEM Part # Available)
ARMATURE ASSEMBLY (115VAC)
• Includes Amature Washer Kit
(RPI Part #STK033)
Models: 940

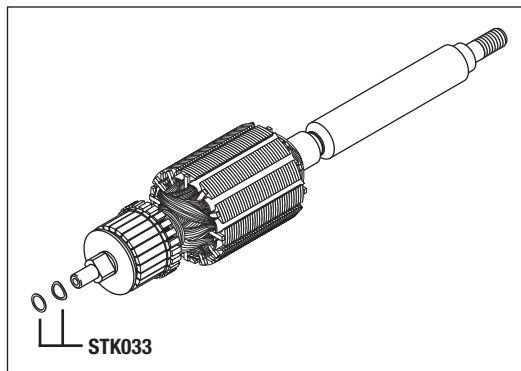

STK033

RPI Part #STK033
OEM Part # (No OEM Part # Available)
ARMATURE WASHER KIT
Models: 940 & 941

Also fits 800 Series!

RPI Part #STB002
OEM Part #870-1-13, 940-1-113
(Brush only), 38-49 (Spring only)
BRUSH (2/pkg)
Models: 940 & 941

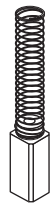

RPI Part #RPC667
OEM Part #58-18
BRUSH CAP (6/pkg)
Models: 940 & 941



replacement parts industries, inc.

CALL (800) 221-9723 • FAX (818) 882-7028 • EMAIL order@riparts.com • WEBSITE www.riparts.com

The above parts are manufactured by Replacement Parts Industries, Inc. to fit Stryker equipment. All product names used in this document are trademarks or registered trademarks of their respective holders. Web 01/10



replacement parts industries, inc.

CALL (800) 221-9723 • FAX (818) 882-7028 • EMAIL order@rpiparts.com • WEBSITE www.rpiparts.com

RPI Part #STS034

OEM Part # (No OEM Part # Available)

POWER SWITCH

Models: 940 & 941

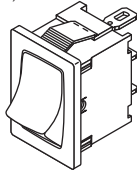

RPI Part #STL035

OEM Part # (No OEM Part # Available)

POWER SWITCH LABEL (3/pkg)

Models: 940 & 941

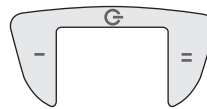

RPI Part #RPS639

OEM Part # (No OEM Part # Available)

SILICONE GASKET MAKER 598

Models: 940 & 941

*Perfect for sealing
Power Switch
connections!*

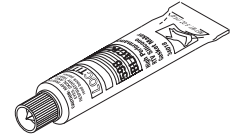

RPI Part #STL016

OEM Part # (No OEM Part # Available)

SHAFT LINK

Models: 940 & 941

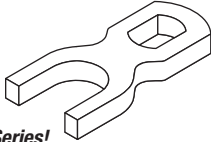

Also used with 800 Series!

RPI Part #STT010

OEM Part # (No OEM Part # Available)

CAM TOOL

• Used to install and remove Cam
(RPI Part #STC029 & STC009)

Models: 940 & 941

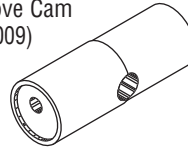

Also used with 800 Series!

RPI Part #STC029

OEM Part # (No OEM Part # Available)

CAM

Models: 940 & 941

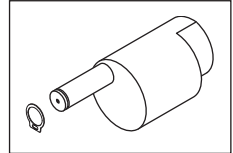

RPI Part #STK037

OEM Part # (No OEM Part # Available)

POWER CABLE KIT

• Includes all parts as shown
Models: 940 & 941

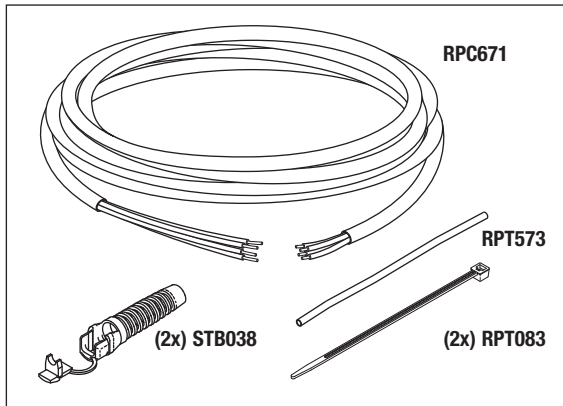

RPI Part #RPC671

OEM Part # (No OEM Part # Available)

CABLE (4 CONDUCTOR)

• Sold by the foot (reel not included)
Models: 940 & 941

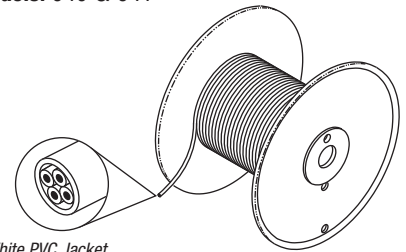

• White PVC Jacket
• Colors: black, red, green, and yellow

RPI Part #STB038

OEM Part # (No OEM Part # Available)

STRAIN RELIEF BUSHING (5/pkg)

Models: 940 & 941

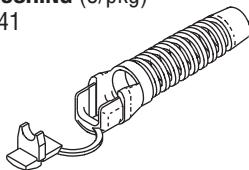

RPI Part #RPT172

OEM Part # (No OEM Part # Available)

STRAIN RELIEF BUSHING PLIERS

Models: 940 & 941

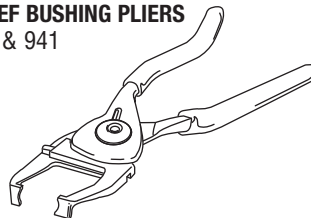

RPI Part #RPS672

OEM Part # (No OEM Part # Available)

CORD STRAP (WHITE 6") (3/pkg)

Models: 940 & 941

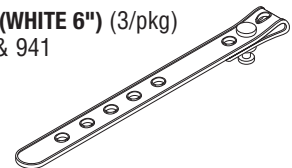

*Perfect for strapping the Power Cord
to the Vacuum Hose!*

**Just a Reminder ... RPI also has parts to fit
Stryker 800 Series Autopsy Saws, Cast Cutters and Vacuums!**

